

**Sabine Pass to Galveston Bay, Texas
Coastal Storm Risk Management and Ecosystem
Restoration
Final Integrated Feasibility Report and
Environmental Impact Study**

APPENDIX A

MEASURE INFORMATION SHEETS

May 2017

SABINE PASS TO GALVESTON BAY, TEXAS
MEASURE 1
INFORMATION SHEET

DESCRIPTION OF MEASURE 1: The Ike Dike, Chambers, Galveston and Harris Counties

Texas A&M University at Galveston (TAMUG) and the City of Galveston are sponsoring a study of the Ike Dike proposal for storm surge protection of Galveston Island and Galveston Bay. The Ike Dike is a surge barrier system located along the Gulf of Mexico coastline that would protect the entire Galveston Bay system. The plan consists of approximately 62 miles of dike and an existing seawall, and two new gated structures. This measure was developed with general information provided by TAMUG. The Ike Dike measure would adhere to the following four principles:

- shorten the perimeter of the flood defense system as much as possible,
- keep the surge out of internal waters,
- use gated barriers to allow shipping, and,
- conserve and/or improve the ecology of the bay.

LOCATION OF MEASURE: (See attached drawing Measure 1-Ike Dike)

DESIGN ASSUMPTIONS

Dike: The proposed crest height of the dike would be NAVD 88 17 feet, the same height as the Galveston Seawall. The Ike Dike would protect all of the property surrounding Galveston Bay, including the cities of Houston and Galveston, communities around the east and west shorelines of Galveston Bay, as well as portions of Bolivar Peninsula and West Galveston Island. The total length of the new dike, not including the existing Galveston Sewall, would be about 52 miles. The dike would be constructed as a raised highway, following the right-of-way of existing highways on Bolivar Peninsula and West Galveston Island. The measure, as presented here, does not include necessary extensions at the eastern and western ends to reach corresponding inland elevations in Chambers and Brazoria counties, and similarly, it does not provide for gates where these extensions would cross the GIWW.

Surge Gates: The two surge gates would be located in the Houston-Galveston Ship Channel Entrance at Bolivar Roads and in San Luis Pass.

The Houston-Galveston Ship Channel Entrance would feature a 590 feet-wide floating sector gate barrier. Two vertical lifting gate barriers would provide access for barges. Smaller vertical lifting gates would allow circulation of water but close the inlet in case of storm surge.

The approximately 2,625 feet-wide San Luis Pass, is located at the west end of Galveston Island. The San Luis Pass Bridge limits the maximum size of the vessels to a width of about 33 feet. A vertical lift barrier would ensure passage of the small recreational vessels that currently utilize the pass. San Luis Pass is not an authorized navigation channel and it is not proposed that the barrier would be designed to accommodate commercial navigation. A set of smaller vertical lift gate barriers would allow tidal exchange.

HYDRAULICS & HYDROLOGY

The design storm used for the H&H analysis is the 100-year storm surge derived by FEMA using the recent results from the FEMA 2011 Texas coastal study. The ADCIRC results were converted into a Without-Project 100-year flood depth grid that corresponds to the existing Without-Project condition.

Although the without-project 100-year flood depth grids show the Texas City Hurricane Flood Protection (HFP) system as functioning for a 100-year surge, this study assumes that it would fail since it has designs similar to those found in the New Orleans HFP project and do not include current USACE standards for resiliency and redundancy features that are critical for life-safety structures.. The data derived for damages associated with the Texas City HFP system were provided from a recent levee safety risk assessment completed by USACE Galveston District and data from the National Levee Database. The Without-Project flood depth grid is used to estimate the With-Project benefits as the Without-Project flood grid represents the reconstructed system performing fully at a 100-year surge level.

Assumptions included the following:

The Ike Dike includes the seawall and the seawall is up to design standards.

No surge will come through the Ike Dike into Galveston Bay for a 100-year design storm. It is also assumed no overtopping will occur. (100% Effective)

REAL ESTATE

A detailed breakdown of Real Estate costs can be found in the supplemental document 'Sabine Pass to Galveston Bay, Texas Preliminary Real Estate Cost Estimate'.

Measure 1 - The Ike Dike, Chambers, Galveston and Harris Counties

Total Estimated Real Estate Cost:

\$142,500,000 ®

ENVIRONMENTAL

The Ike Dike would be a combination of an open and a closed system, as complete closure would have major implications on the ecology of the Galveston Bay system. During normal (non-flood) conditions, the surge gates should allow free water flow while assuring safe navigation. However, a barrier in Bolivar Roads would reduce the Bolivar Roads flow area by 40 to 60%, leading to a decrease of the tidal prism between 21 and 41% (Ruijs, 2011). Because of the smaller tidal prism, an increase in residence time, and a decrease in salinity could be expected. The reduction of the tidal prism, tidal range and current speeds could cause a redistribution of the sediment from marshes and flats to the channels within the bay. The blocking of sediment from the Gulf of Mexico by the barrier could further enhance this effect. Changes to the hydrodynamics, water quality and morphology in the bay could potentially result in loss of habitat and disturb the ecology. Further research would be required to evaluate these effects.

The surge protection would, however, have some beneficial effects on forested and emergent marsh wetlands in the Galveston Bay system. The Ike Dike system would not protect the natural environment from damages caused by hurricane-force winds, but it would reduce surge damages due to scouring and marsh loss due to elevated salinities following the storm. Environmental benefits are presented in wetland acres that would be protected by this measure. The wetland acres were calculated with a GIS analysis of National Wetland Inventory wetland maps (USFWS, 2012) It is estimated that approximately 121,000 acres of wetlands (emergent marsh, bottomland hardwood forest, swamp and scrub-shrub) in the Galveston Bay area would be protected from adverse surge effects. These sensitive wetland areas include the USACE Wallisville Lake Project and the Anahuac National Wildlife Refuge.

BENEFITS

With and without project damages to structures, contents, and vehicles were calculated using HEC-FIA (Flood Impact Analysis) software package which analyzes consequences for a given flood event, in this case, a 1% annual exceedence probability (100-year). Without-project damages are those that would occur under the current existing condition. Residual damages are those that would occur with a given measure in place. Benefits are the difference between the two. These numbers are listed in the tables below.

This economic analysis does not take into account loss of human life or impacts to the economy of the region that would result from economic and industrial disruptions caused by storm surge.

The U.S. Department of Commerce, Economic Development Administration partnered with the Texas Engineering Extension Service (TEEX) in a study examining the economic impact of Hurricane Ike to an eight-county region including the six counties in the Sabine to Galveston study (Brazoria, Chambers, Galveston, Harris, Jefferson, Orange) and two additional inland counties (Liberty, Tyler). The study's Disaster Impact Model calculated the total economic impact of Hurricane Ike for the 12 months immediately following the storm to be an estimated \$142 billion (TEEX, no date).

Storm Surge Regions

Region	Counties
6	Brazoria, Galveston, Harris
7	Chambers, Galveston, Harris, Jefferson
8	Chambers, Jefferson, Orange

Benefits for Measure 1 – The Ike Dike, Chambers, Galveston and Harris Counties

Region 6			
	Without Project Damages	Residual Damages	Benefits
Structure	\$5,630,895,000	\$378,371,000	\$5,252,524,000
Contents	\$5,854,589,000	\$351,748,000	\$5,502,841,000
Vehicles	\$1,337,005,000	\$109,829,000	\$1,227,176,000
Total	\$12,822,489,000	\$839,948,000	\$11,982,541,000

Region 7			
	Without Project Damages	Residual Damages	Benefits
Structure	\$1,016,448,000	\$16,916,000	\$999,532,000
Contents	\$833,516,000	\$20,703,000	\$812,813,000
Vehicles	\$252,516,000	\$4,978,000	\$247,538,000
Total	\$2,102,480,000	\$42,597,000	\$2,059,883,000

Total Combined Region 6 and Region 7 Benefits \$14,042,424,000

COSTS

The Total Project Cost without RE cost is estimated to be \$6,090,000,000. This cost is derived from the TAMU IKE Dike report (see reference below). A detailed breakdown of this cost was not available and therefore no review of reasonableness was possible.

REFERENCE DOCUMENTS

The design and cost developed in the following report were used: Applying best practices from the Delta Works and New Orleans to Galveston Bay, Prepared by: Kasper Stoeten, Master Student Hydraulic Engineering, Delft University of Technology, November 2012. A copy of this report with eight appendices can be found on SharePoint:

<https://extranet.dse.usace.army.mil/sites/Divisions/SWD/SWG/S2G/default.aspx>

Discussion of environmental effects of the Ike Dike barrier were based, in part, on a report entitled The effects of the "Ike Dike" barriers on Galveston Bay, prepared by M. Ruijs (2011). A copy of this report can be found on SharePoint:

<https://extranet.dse.usace.army.mil/sites/Divisions/SWD/SWG/S2G/default.aspx>

Texas Engineering Extension Service (TEEX). No Date. Hurricane Ike Impact Report, Accessed on the internet at <http://www.thestormresource.com/index.aspx>

U.S. Fish and Wildlife Service (USFWS). 2012. National Wetland Inventory. Accessed on the internet at <http://www.fws.gov/wetlands/Data/Mapper.html>

RISKS:

- Geotechnical feasibility of the proposed storm protection system was not studied. Complex geology and hydrology of San Luis Pass will present design challenges.
- No review of available public information or data from in-house files relative to the general geology and soil conditions along the proposed alignments was conducted.
- No preliminary assessment of possible levee or flood-wall cross-sections, or considerations for additional study for the preliminary and final design was considered.
- System configuration and gated structures were not assessed.
- It was assumed that every 15 years the vertical lift surge gates at Bolivar Roads and San Luis Pass would need to be removed and rehabbed.
- Relocation of utilities and acquisition of ROW for measures has not been accounted for.
- Extensive H&H modeling and environmental impact evaluation would be needed to evaluate ecological effects of decreased tidal flows into Galveston Bay.
- This environmental analysis does not take into account environmental impacts that would occur without the surge protection system as a result of contaminant spills from the high number of petro-chemical plants and other industrial facilities on the Houston Ship Channel and in the Barbour's Cut and Bayport areas.

- Existing surge runs are available for the with-project condition performed by others but were not utilized for this stage of analysis. These would have to be examined during future phases of the study if this measure goes forward.
- It will be very important if this measure is pursued to accurately understand the impacts at the ends of the Dike. There could be an increase in surge where the Ike Dike ends and fully understanding this consequence should involve ADCIRC modeling.
- Modeling is needed to evaluate the effect of overtopping of the system in case a larger storm than the 100-year event occurs. If water gets trapped behind the Ike Dike and it takes longer to drain than it would without the Ike Dike in place, there could be significant consequences.
- The assumption that the system is 100% effective (no surge into Galveston Bay) was used for initial assessment. Current design is based on TAMUG Ike Dike which would allow some level of overtopping.

Measure 1 - The Ike Dike, Chambers, Galveston and Harris Counties

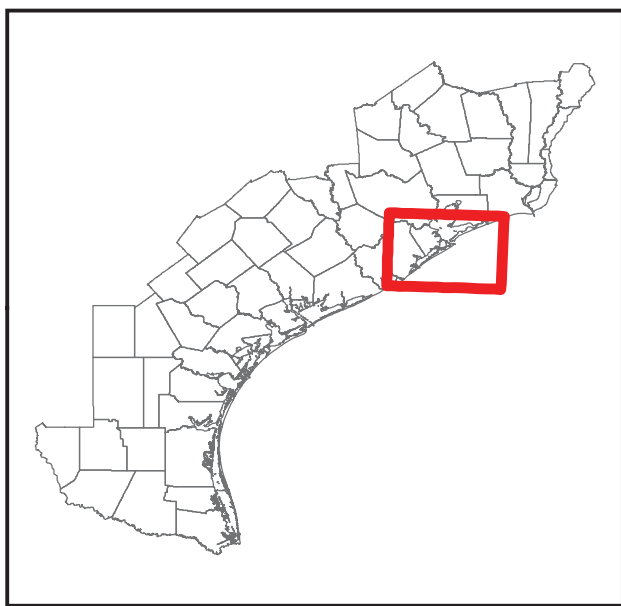

Legend

Measure_Number

- Levee System
- Surge Gates

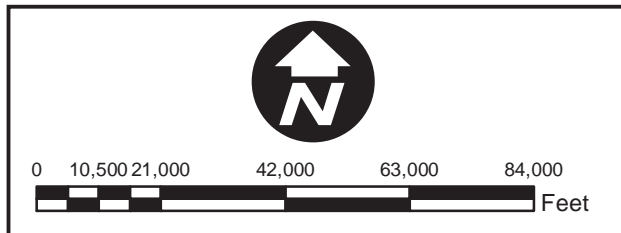

This product is reproduced from geospatial information prepared by the U.S. Army Corps of Engineers. GIS data and product accuracy may vary. Data may be developed from sources of differing accuracy, accurate only at certain scales, based on modeling or interpretation, incomplete while being created or revised, etc. Using GIS products for purposes other than those for which they were created may yield inaccurate or misleading results. The Corps of Engineers reserves the right to correct, update, modify, or replace GIS products without notifications.

SABINE PASS TO GALVESTON BAY, TEXAS
MEASURE 2
INFORMATION SHEET

DESCRIPTION OF MEASURE 2 Surge Gate and Barrier at Hartman Bridge, Harris County.

The proposed surge barrier at the Fred Hartman Bridge in Harris County would consist of a principal navigation gated structure, smaller gated structures and a levee barrier system designed to protect the industrial areas adjacent to the Houston Ship Channel (HSC) north of the Fred Hartman Bridge as well as communities and businesses located within the area. The proposal for the HSC surge system has been developed by the Severe Storm Prediction, Education and Evacuation from Disasters (SSPEED) Center, which was established in 2007 as a university-based research and education organization. Led by Rice University, the SSPEED Center organizes leading universities, researchers, emergency managers, and private and public entities to better address severe storm prediction and its impact on the Gulf Coast area. This measure was developed, in part, using general information provided by the SSPEED Center. The measure includes five miles of levee barrier tying into high ground on either side of the HSC, one principle surge gate across the HSC and one smaller gate at Goose Creek. Additionally, the proposed design could also include two tidal exchange structures, one located at the entrance to Black Duck Bay and one at the entrance to Lower San Jacinto Bay (just west of Spilman Island Placement Area). The gates would remain open to provide access for vessel traffic and allow for circulation of riverine and bay waters, only closing in anticipation of storm surge events.

LOCATION OF MEASURE

See attached drawing Surge Gates and Barrier at Hartman Bridge.

DESIGN ASSUMPTIONS

The proposed crest height for the levees and gates of the surge barrier at Fred Hartman Bridge would be NAVD 88 25 ft. The plan consists of approximately 5 miles of levees to tie into high ground on either side of the barrier system and between the surge gates. The primary gate would be located in the HSC on the southern side of the Fred Hartman Bridge. A second and smaller surge gate is located at Goose Creek.

- The proposed crest height for the surge barrier would be NAVD 88 25 ft.

- A combination of levees and gates would protect the areas north of the Fred Hartman Bridge.
- The plan would consist of approximately 5 mi of levees, one navigation structure and two gated passages.

HYDRAULICS & HYDROLOGY

The design storm used for the H&H analysis is the 100 year storm surge derived by FEMA using the recent results from the FEMA 2011 Texas coastal study. The ADCIRC results were converted into a Without-Project 100-year flood depth grid that corresponds to the existing Without Project conditions. The proposed crest height for the system (25 ft) is based upon the predicted surge height of a modified Hurricane Ike. If a 100-year storm had come ashore further south, near San Luis Pass, the surge up the Ship Channel would have reached almost about 25 feet after taking into account the funneling effects of Galveston Bay.

REAL ESTATE

A detailed breakdown of Real Estate costs can be found in the supplemental document 'Sabine Pass to Galveston Bay, Texas Preliminary Real Estate Cost Estimate'.

Measure 2: Surge Gate and Barrier at Hartman Bridge, Harris County

Total Estimated Real Estate Cost: \$3,400,000 ®

ENVIRONMENTAL

The Surge Gate and Barrier at Hartman Bridge would be a combination of an open and a closed system. During normal (non-flood) conditions, the surge gates should allow free water flow while assuring safe navigation. However, a barrier in the HSC would reduce the flow area in the tidal areas of the lower San Jacinto River and Buffalo Bayou by an unknown amount. Because of the smaller tidal prism and an increase in residence time, a decrease in tidal flushing could be expected. Changes to the hydrodynamics, water quality and morphology in the lower San Jacinto River/Buffalo Bayou systems could potentially result in loss of habitat and disturb the ecology. Further research would be required to evaluate these effects.

The surge protection would however have some beneficial effects on forested and emergent marsh wetlands in the lower San Jacinto River/Buffalo Bayou systems. The Ike Dike system would not protect the natural environment from damages caused by hurricane-force winds, but it would reduce surge damages due to scouring and marsh loss due to elevated salinities following the storm. Environmental benefits are presented in wetland acres that would be protected by this

measure. The wetland acres were calculated with a GIS analysis of National Wetland Inventory wetland maps (USFWS, 2012). It is estimated that approximately 3,200 acres of wetlands (emergent marsh, bottomland hardwood forest, swamp and scrub-shrub) in the affected area would be protected from adverse surge effects.

BENEFITS

With and without project damages to structures, contents, and vehicles were calculated using HEC-FIA (Flood Impact Analysis) software package which analyzes consequences for a given flood event, in this case, a 1% annual exceedance probability (100-year). Without project damages are those that would occur under the current existing condition. Residual damages are those that would occur with a given measure in place. Benefits are the difference between the two. These numbers are listed in the tables below.

This economic analysis does not take into account losses of human life or impacts to the economy of the region that would result from economic and industrial disruptions caused by storm surge. It could take weeks to get critical petro-chemical facilities back on-line, and months to clean-up and fully repair flooded facilities. The lives of thousands of people would be disrupted until homes could be rebuilt, and temporary dislocations would adversely affect employers who would lose employees as they relocate to other areas.

Storm Surge Regions

Region	Counties
6	Brazoria, Galveston, Harris
7	Chambers, Galveston, Harris, Jefferson
8	Chambers, Jefferson, Orange

Benefits for Measures 2 (Region 6)

Region 6			
	Without Project Damages	Residual Damages	Benefits
Structure	\$5,630,895,000	\$4,510,957,000	\$1,119,938,000
Contents	\$5,854,589,000	\$4,483,304,000	\$1,371,285,000
Vehicles	\$1,337,005,000	\$1,079,836,000	\$257,169,000
Total	\$12,822,489,000	\$10,074,097,000	\$2,748,392,000

Benefits for Measures 2 (Region 7)

Region 7			
	Without Project Damages	Residual Damages	Benefits
Structure	\$1,016,448,000	\$863,739,000	\$152,709,000
Contents	\$833,516,000	\$709,642,000	\$123,874,000
Vehicles	\$252,516,000	\$223,310,000	\$29,206,000
Total	\$2,102,480,000	\$1,796,691,000	\$305,789,000

Total Region 6 and Region 7 \$3,054,181,000

COSTS

This cost does not include real estate. The Total Project Cost is \$ 798,442,000.00.

It was assumed that every 15 years the gates would need to be removed and rehabbed. This cost was estimated based, in part, on preliminary costs developed for the TAMUG IKE Dike project (Stoeten, 2012). A detailed breakdown of this cost was not available and therefore no review of reasonableness was possible.

REFERENCE DOCUMENTS

The cost, gates and levee designs developed in the report: Applying best practices from the Delta Works and New Orleans to Galveston Bay, Prepared by: Kasper Stoeten, Master Student Hydraulic Engineering, Delft University of Technology, November 2012 were used. A copy of this report with eight appendices can be found on SharePoint:

<https://extranet.dse.usace.army.mil/sites/Divisions/SWD/SWG/S2G/default.aspx>

The drawings showing the alignment were taken from a PowerPoint presentation by Tom Colbert at the Gulf Coast Hurricanes: Mitigation and Response Conference (April 10-11, 2012), sponsored by the Severe Storm Prediction, Education and Evacuation from Disasters Center (SSPEED), Rice University.

U.S. Fish and Wildlife Service (USFWS). 2012. National Wetland Inventory. Accessed on the internet at <http://www.fws.gov/wetlands/Data/Mapper.html>

RISKS:

- Geotechnical feasibility of the proposed storm protection system was not studied.
- No review of available public information or data from in-house files relative to the general geology and soil conditions along the proposed alignments was conducted.
- No preliminary assessment of possible levee cross-sections was considered.
- System configuration and gated structures were not assessed.
- The unit cost developed in the report: Applying best practices from the Delta Works and New Orleans to Galveston Bay, Prepared by: Kasper Stoeten, Master Student Hydraulic Engineering, Delft University of Technology, November 2012 were used to develop this measure.
- It was assumed that every 15 years the gates would need to be removed and rehabbed. This needs to be investigated and validated.
- Relocation of utilities and acquisition of ROW for measures has not been accounted for.
- Extensive H&H modeling and environmental impact evaluation would be needed to evaluate ecological effects of decreased tidal flows into the lower San Jacinto River/Houston Ship Channel system.
- This environmental analysis does not take into account environmental impacts that would occur without the surge protection system as a result of contaminant spills from the high number of petro-chemical plants and other industrial facilities on the Houston Ship Channel and in the Barbour's Cut and Bayport areas.
- Existing surge runs are available for the with-project condition performed by others but were not utilized for this stage of analysis. These would have to be examined during future phases of the study if this measure goes forward.
- There could be an increase in surge where the HSC system ends which would require ADCIRC modeling to fully investigate.
- Modeling is needed to evaluate the effect of overtopping of the system in case a larger storm than the 100-year occurs. If water gets trapped behind the surge system and it takes longer to drain. there could be significant consequences.

Measure 2: Surge Gate and Barrier at Hartman Bridge, Harris County



Legend

Name

● Surge Gate

Name

— Levee Walls

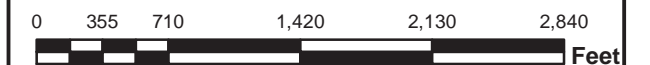

This product is reproduced from geospatial information prepared by the U.S. Army Corps of Engineers. GIS data and product accuracy may vary. Data may be developed from sources of differing accuracy, accurate only at certain scales, based on modeling or interpretation, incomplete while being created or revised, etc. Using GIS products for purposes other than those for which they were created may yield inaccurate or misleading results. The Corps of Engineers reserves the right to correct, update, modify, or replace GIS products without notifications.

Date Created: 4/12/2013



**SABINE PASS TO GALVESTON BAY, TEXAS
MEASURES 3-1, 3-2, and 3-3
INFORMATION SHEET**

DESCRIPTION OF MEASURES:

3-1 Port Arthur and Vicinity, Texas Hurricane Flood Protection;

3-2 Texas City, Texas Hurricane Flood Protection;

3-3 Freeport and Vicinity, Texas Hurricane Flood Protection

Measures 3-1, 3-2, and 3-3 involve reevaluating and adding resiliency features to existing Hurricane Flood Protection (HFP) systems at Port Arthur, Texas City, and Freeport. These measures would reconstruct various parts of the existing systems to reduce their risk of failure and thereby raise their level of protection. The resiliency features correct items with similar designs as those found in the New Orleans HFP that did not perform well during Hurricane Katrina. Some of the deficiencies identified in New Orleans include lack of overtopping protection, high stick-up heights of floodwall elements, vulnerabilities to erosion at transitions between different components of the system, use of erodible materials for construction of earthen levees, improper design heights for hurricane protection components, and general lack of resiliency and/or redundancy for critical life safety structures (Wooten, 2009). The HFP systems at Port Arthur, Texas city and Freeport would experience overtopping at the design storm from waves and splash-over. The increased level of protection provided by the newly constructed resiliency features would decrease the flood risk to the protected communities.

Measure 3-1 Port Arthur and Vicinity, Texas Hurricane Flood Protection, Jefferson County, Texas. This measure would evaluate the existing hurricane protection system at Port Arthur. Construction of the existing hurricane protection system was completed in April, 1982. The HFP system includes 27.8 miles of earthen embankment and 6.6 miles of floodwall protecting a population of 89,705. The system was designed and constructed for a 100-year storm event. The proposed Port Arthur System reevaluation would consist of adding resiliency features to reduce flood risk, and thereby increasing the level of protection. These features consist of embankment overtopping erosion protection, floodwall tie-in protection, and floodwall overtopping erosion protection.

Measure 3-2 Texas City, Texas Hurricane Flood Protection, Galveston County, Texas. This measure would evaluate the existing HFP system at Texas City (including the existing guillotine gate). Construction of the existing hurricane protection system at Port Arthur, Texas was completed in 1987. The HFP system includes 20.5 miles of earthen embankment and 1.3 miles of floodwall protecting a population of 42,144. The system was designed and constructed for a

100-year event. The Texas City System reevaluation would consist of adding resiliency features to reduce flood risk, thereby increasing the level of protection. These features consist of embankment overtopping erosion protection, floodwall tie-in protection, and floodwall overtopping erosion protection.

Measure 3-3 Freeport and Vicinity Hurricane Flood Protection, Brazoria County, Texas.

This measure would evaluate the existing HFP system at Freeport (including existing guillotine gate). Construction of the existing hurricane protection system at Freeport was completed in January, 1981. The HFP system includes 40.7 miles of earthen embankment and 2.6 miles of floodwall protecting a population of 45,903. The system was designed and constructed for a 100-year event. The Freeport system reevaluation would consist of adding resiliency features and correcting changed conditions that have reduced the factors of safety on key components of the system. These features consist of embankment overtopping erosion protection, floodwall tie-in protection, and floodwall overtopping erosion protection, along with features that would address general stability issues. These measures would reconstruct various parts of the existing systems to reduce their risk of failure and thereby raise their level of protection.

LOCATION OF MEASURES

- Measure 3-1 Port Arthur and Vicinity, Texas Hurricane Flood Protection, Jefferson County, Texas (See attached drawing)
- Measure 3-2 Texas City, Texas Hurricane Flood Protection, Galveston County, Texas (See attached drawing)
- Measure 3-3 Freeport and Vicinity Hurricane Flood Protection, Brazoria County, Texas (See attached drawing)

DESIGN ASSUMPTIONS

Measure 3-1: Would provide items listed with assumed specifications.

1. Turf Reinforcement: The overtopping protection and erosion control for levee embankments would consist of turf reinforcement on the protected side.
 - Overtopping protection and erosion control along earth embankments. Assume 2/3 of levees.
 - Quantity: 18.5 miles x 100 ft.
 - 2. Grouted Riprap Reinforcement: The floodwall tie-in to levee consists of 20 inch riprap grouted in place for each tie-in at 38 locations.
 - All material to be trucked to site.

2. Floodwall Scour Protection: The floodwall scour protection would consist of fill on the protected side of the floodwall and concrete scour protection on top of the fill.

Measure 3-2: Would provide items listed with assumed specifications.

1. Turf Reinforcement: The overtopping protection and erosion control for levee embankments would consist of turf reinforcement on the protected side.

- Assume 2/3 of levees covered.
- Quantity: 13.3 miles x 100 ft.).

2. Grouted Riprap Reinforcement: The floodwall tie-in to levee consists of 20 inch riprap grouted in place for each tie-in at 18 locations.

- All material to be trucked to site.

3. Floodwall Scour Protection: The floodwall scour protection consists of fill on the protected side of the floodwall and concrete scour protection on top of the fill.

- Provide scour protection along floodwalls.
- Assume 2/3rd of levees covered
- Quantity: 1.32 miles x 25 ft x 8 inch

Measure 3-3: Would provide items listed with assumed specifications. Design and costs were provided by the Velasco Drainage District.

The overtopping protection and erosion control for levee embankments would consist of turf reinforcement on the protected side. The floodwall tie-in to the levee consists of 20 inch riprap grouted in place for each tie-in. The floodwall scour protection would consist of fill on the protected side of the floodwall and concrete scour protection on top of the fill. In addition to the resiliency features, items identified by the USACE (2011) and the local sponsor (Baker & Lawson, 2011) that require action to ensure an adequate level of protection would be included, such as increasing levee stability at Dow Plant A, removing abandoned infrastructure, strengthening I-walls to current design requirements, addressing seepage and erosion issues due to sand and utilities, and addressing height deficiencies.

HYDRAULICS & HYDROLOGY ASSUMPTIONS

The design storm used for the H&H analysis is the 100 year storm surge derived by FEMA using the recent results from the FEMA 2011 Texas coastal study. The ADCIRC results were converted into a Without-Project 100-year flood depth grid that corresponds to the existing Without Project condition.

Although the Without-Project 100 Year flood depth grids show the Port Arthur, Freeport, and Texas City as functioning for a 100 year surge, this study this study assumes that they would fail since they have designs similar to those found in the New Orleans HFP project and do not include current USACE standards for resiliency and redundancy features that are critical for life-safety structures. The data derived for damages associated with the areas behind the three existing surge protection systems was provided from a recent levee safety risk assessment completed by USACE Galveston District and data from the National Levee Database. For each of these measures the Without-Project flood depth grid is used to estimate the With-Project benefits as the Without-Project flood grid represents the reconstructed system performing fully at a 100-year surge level.

REAL ESTATE

A detailed breakdown of Real Estate costs can be found in the supplemental document 'Sabine Pass to Galveston Bay, Texas Preliminary Real Estate Cost Estimate'. Costs identified as \$0 are generally associated with Federal and/or State lands.

Measure 3-1: Port Arthur and Vicinity, Texas Hurricane Flood Protection

Total Estimated Real Estate Cost: \$239,000 ®

Measure 3-2: Texas City, Texas Hurricane Flood Protection

Total Estimated Real Estate Cost: \$49,000 ®

Measure 3-3: Freeport and Vicinity, Texas Hurricane Flood Protection

Total Estimated Real Cost: \$0

ENVIRONMENTAL

All three of these measures protect dense residential and industrial developments. For this initial evaluation, it was assumed that there would be no wetland benefits. Further evaluation would need to take into account potential benefits to Moses Lake and Dollar Bay which are protected by the Texas City HFP system. The total wetland acres environmental benefit for each measure was assumed to be “0.”

BENEFITS

Economic benefits were estimated based upon direct damages from failure of the HFP systems contained in the National Levee Database.

Measure 3-1 Port Arthur and Vicinity, Texas Hurricane Flood Protection: \$4,446,703,670

Measure 3-2 Texas City, Texas Hurricane Flood Protection: \$2,139,338,620

Measure 3-3 Freeport and Vicinity, Texas Hurricane Flood Protection: \$2,195,837,080

COSTS

None of the estimated cost include real estate costs.

Measure 3-1: The total estimated cost for this measure is \$63,909,000.

Measure 3-2: The estimated cost for this measure is \$36,936,000.

Measure 3-3: The estimated cost for this measure is \$123,784,337. The cost for this measure was provided by Velasco Drainage District.

REFERENCE DOCUMENTS

Applying Best Practices from the Delta Works and New Orleans to Galveston Bay,
Prepared by: Kasper Stoeten, Master Student Hydraulic Engineering, Delft University of
Technology, November 2012.

Reconnaissance of the New Orleans Hurricane and Storm Damage Risk Reduction System after
Hurricane Gustav. Principal Author: R. Lee Wooten, P.E., prepared for Geoengineering Extreme
Events Reconnaissance Association, sponsored by the National Science Foundation. February
2009

Levee Deficiency Report: Freeport and Vicinity Hurricane Protection System. Prepared by Baker
& Lawson, Inc for Velasco Drainage District. July 2011

Freeport and Vicinity Hurricane Flood Protection Project 2011 Inspection, US Army Corps of
Engineers Galveston District, October 2011.

RISKS

- Geotechnical and Structural feasibility of the proposed features was not studied.
- No review of available public information or data from in-house files relative to the general geology and soil conditions along the proposed alignments was conducted.
- The unit cost developed in the report: Applying best practices from the Delta Works and New Orleans to Galveston Bay, Prepared by: Kasper Stoeten, Master Student Hydraulic Engineering, Delft University of Technology, November 2012, were used to develop this measure.
- Hydraulics and Hydrology is using information from the levee risk safety assessment to evaluate damages behind each of the levees for a 100 year return period. Rerunning the

ADCIRC storm surge model for the Without Project condition including levee failures would be more accurate.

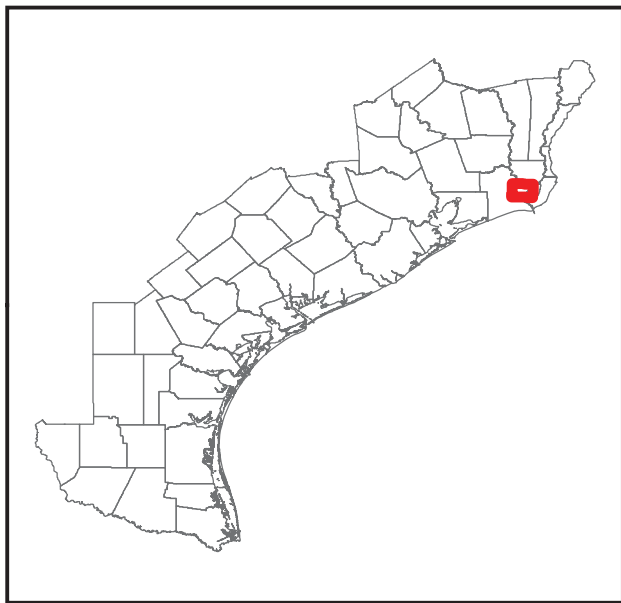
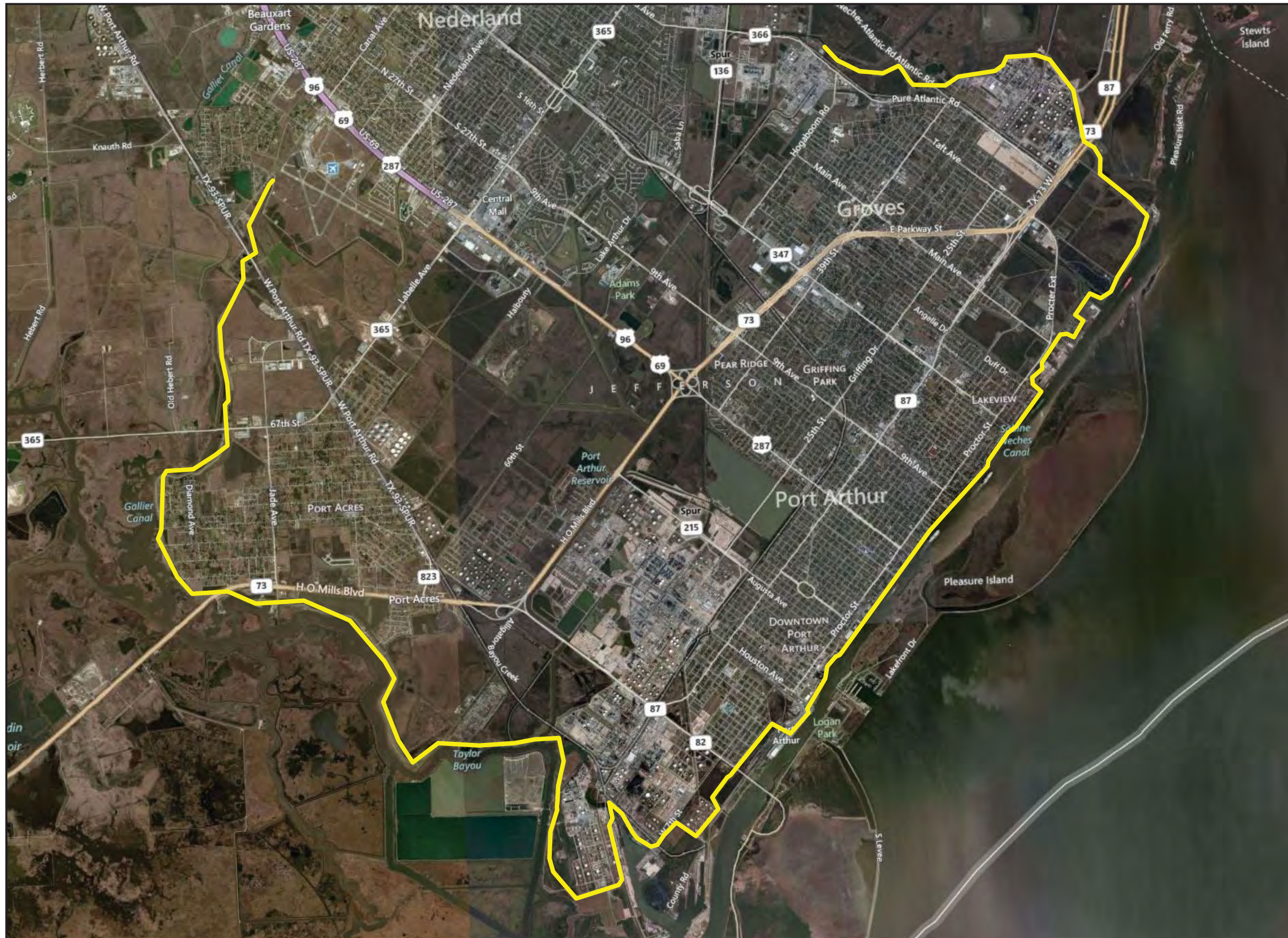

- Orange County has run ADCIRC assuming failure of the Port Arthur levee and that data should be captured at further stages of analysis. It is worthwhile to check and see if any ADCIRC modeling with failure of the Freeport and Texas City levees has been done.
- Relocation of utilities and acquisition of ROW for measures has not been accounted for.
- This environmental analysis does not take into account environmental impacts that would occur without the surge protection system as a result of contaminant spills from the high number of petro-chemical plants and other industrial facilities in the protected area.
- Costs from the National Levee Database likely understate the value of the industrial complexes in the leveed areas and do not include the true economic exposure associated with the systems

Measure 3-1: Port Arthur and Vicinity, Texas Hurricane Flood Protection



Legend

— Port Arthur HFP



 0 1,900 3,800 7,600 11,400 15,200
 Feet

This product is reproduced from geospatial information prepared by the U.S. Army Corps of Engineers. GIS data and product accuracy may vary. Data may be developed from sources of differing accuracy, accurate only at certain scales, based on modeling or interpretation, incomplete while being created or revised, etc. Using GIS products for purposes other than those for which they were created may yield inaccurate or misleading results. The Corps of Engineers reserves the right to correct, update, modify, or replace GIS products without notifications.

Date Created: 4/24/2013

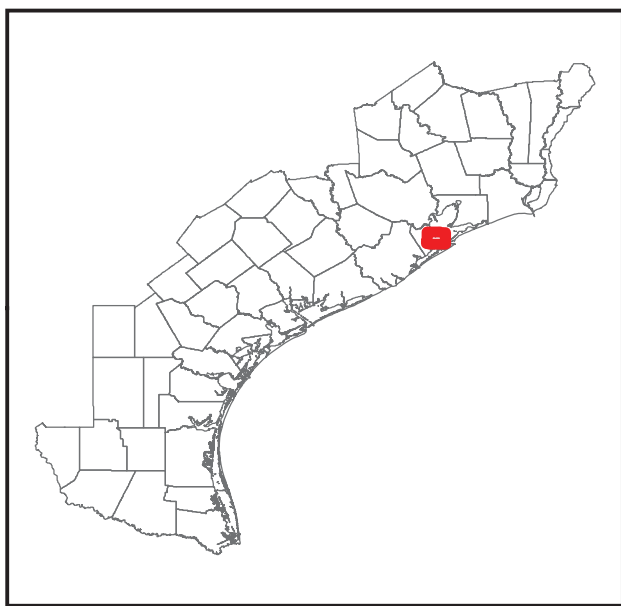
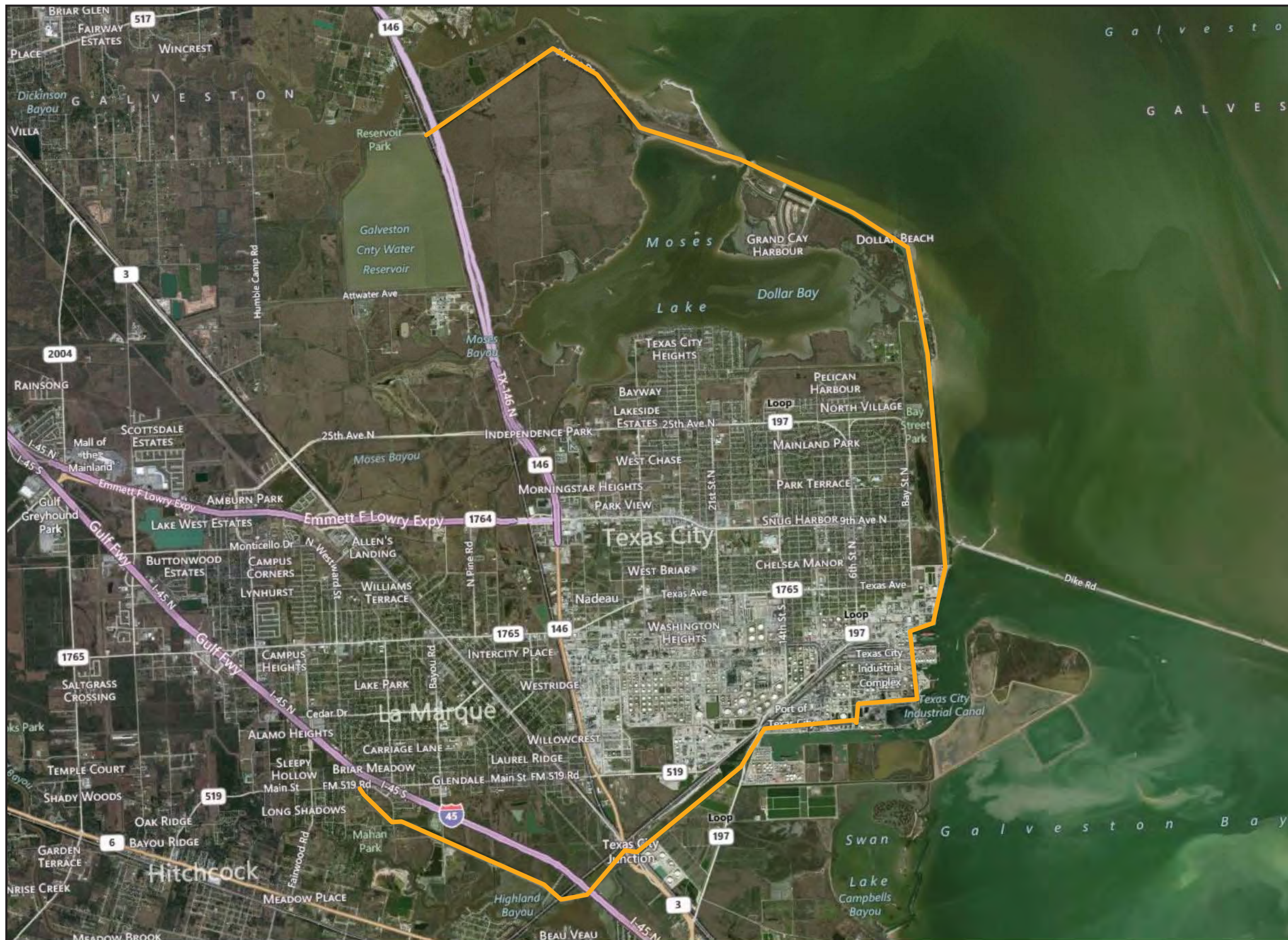

Measure 3-2: Texas City, Texas Hurricane Flood Protection



Legend

 **Texas City HFP**



0 1,700 3,400 6,800 10,200 13,600 Feet



This product is reproduced from geospatial information prepared by the U.S. Army Corps of Engineers. GIS data and product accuracy may vary. Data may be developed from sources of differing accuracy, accurate only at certain scales, based on modeling or interpretation, incomplete while being created or revised, etc. Using GIS products for purposes other than those for which they were created may yield inaccurate or misleading results. The Corps of Engineers reserves the right to correct, update, modify, or replace GIS products without notifications.



 Date Created: 4/24/2013

Measure 3-3: Freeport and Vicinity, Texas Hurricane Flood Protection

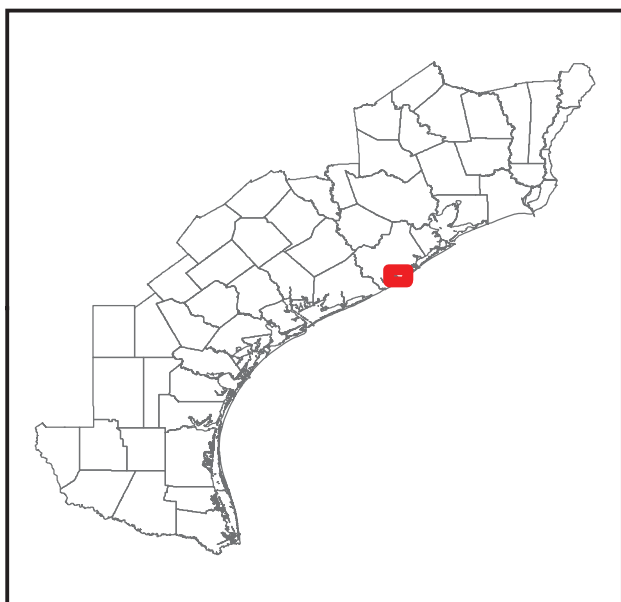
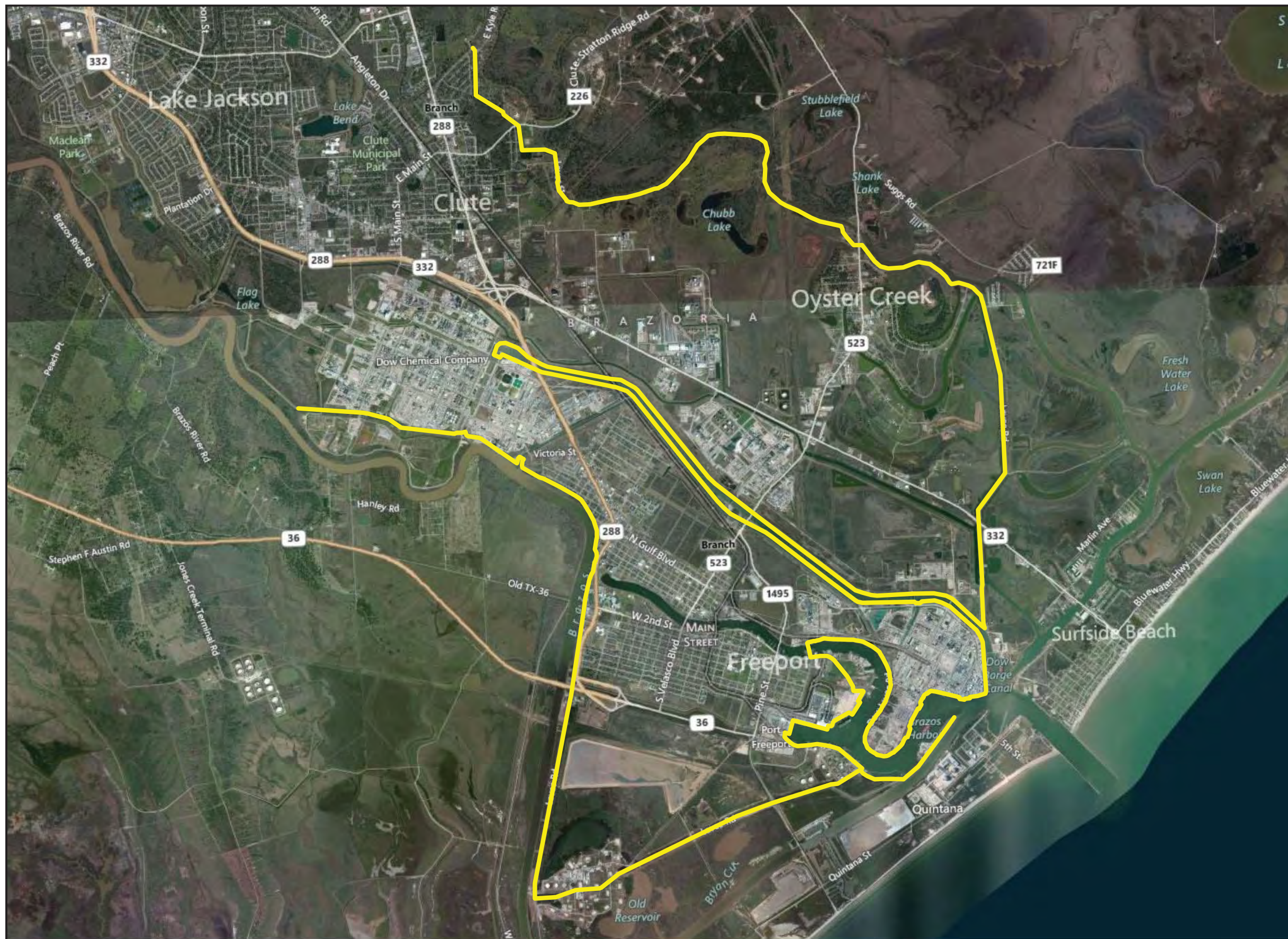

Legend

Name

 **Freeport HFP**



0 1,750 3,500 7,000 10,500 14,000
 Feet

This product is reproduced from geospatial information prepared by the U.S. Army Corps of Engineers. GIS data and product accuracy may vary. Data may be developed from sources of differing accuracy, accurate only at certain scales, based on modeling or interpretation, incomplete while being created or revised, etc. Using GIS products for purposes other than those for which they were created may yield inaccurate or misleading results. The Corps of Engineers reserves the right to correct, update, modify, or replace GIS products without notifications.

Typical Section S-01: Turf Reinforcement

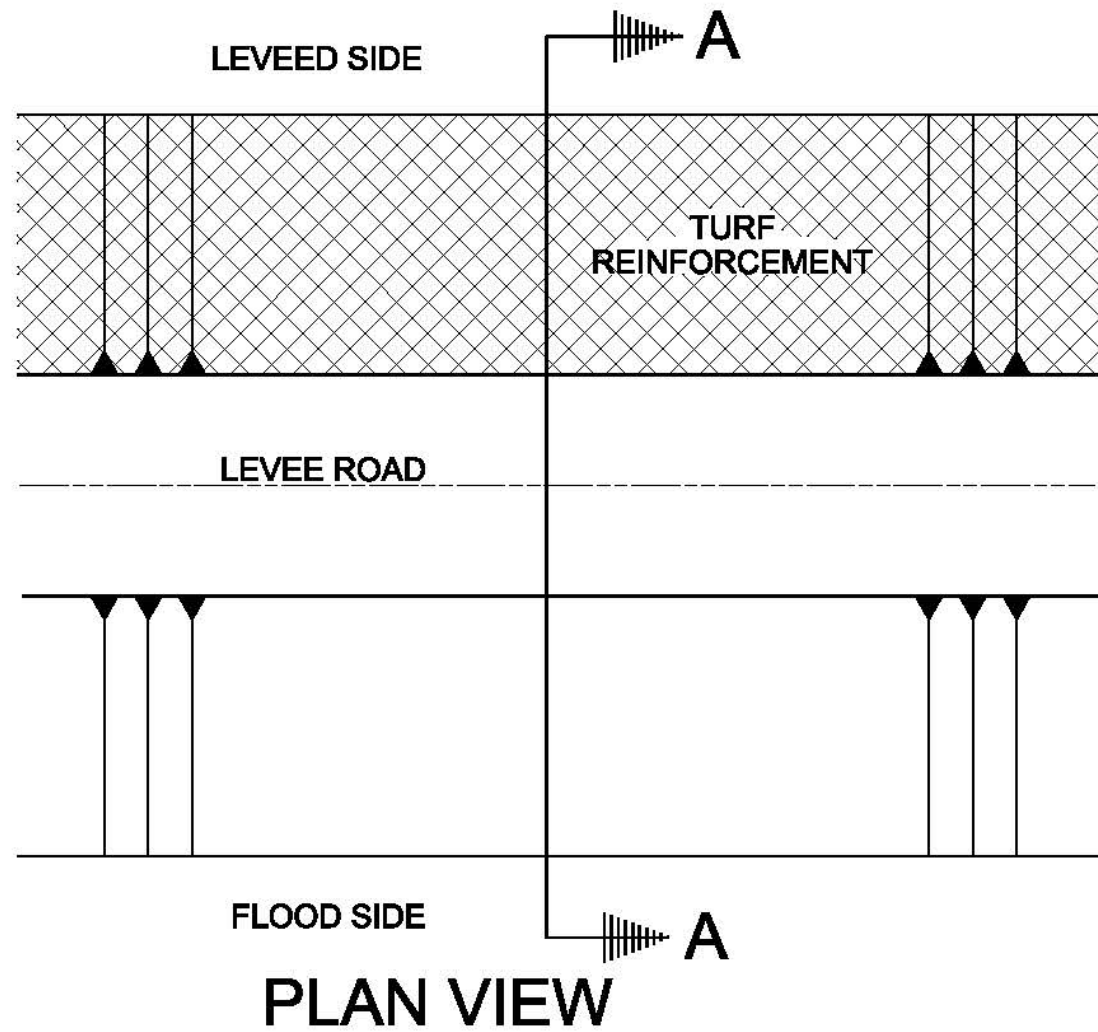

PLAN VIEW

N.T.S.

LEVEED SIDE

FLOOD SIDE

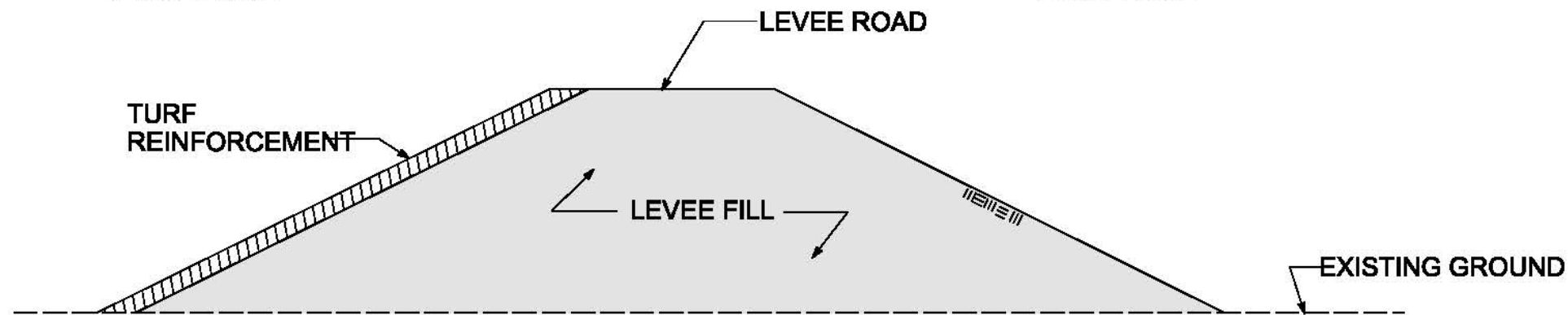

A
S-01/S-01

SECTION

N.T.S.

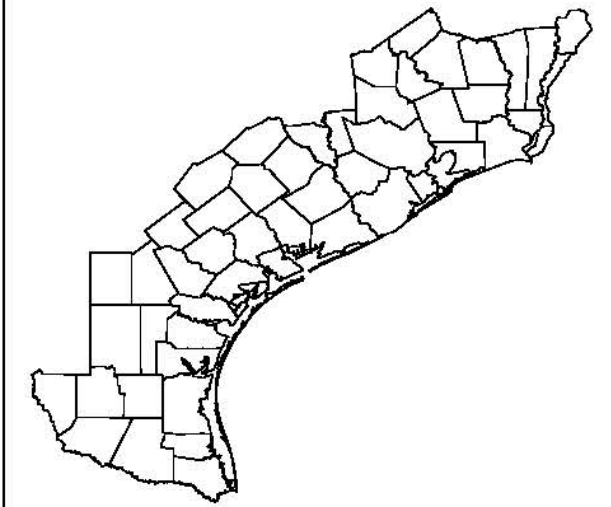

Typical Section S-01

Measures:

- 3-1
- 3-2
- 3-3



This product is reproduced from geospatial information prepared by the U.S. Army Corps of Engineers. GIS data and product accuracy may vary. Data may be developed from sources of differing accuracy, accurate only at certain scales, based on modeling or interpretation, incomplete while being created or revised, etc. Using GIS products for purposes other than those for which they were created may yield inaccurate or misleading results. The Corps of Engineers reserves the right to correct, update, modify, or replace GIS products without notifications.

Date Created: 4/24/2013



Typical Section S-02: Floodwall Tie-in

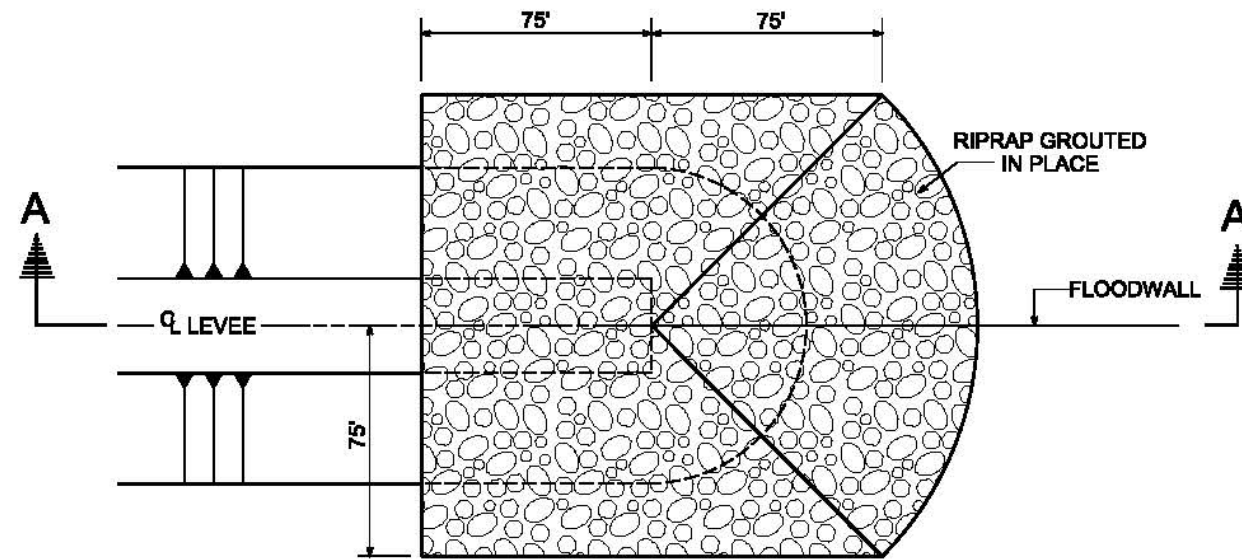

PLAN VIEW

N.T.S.

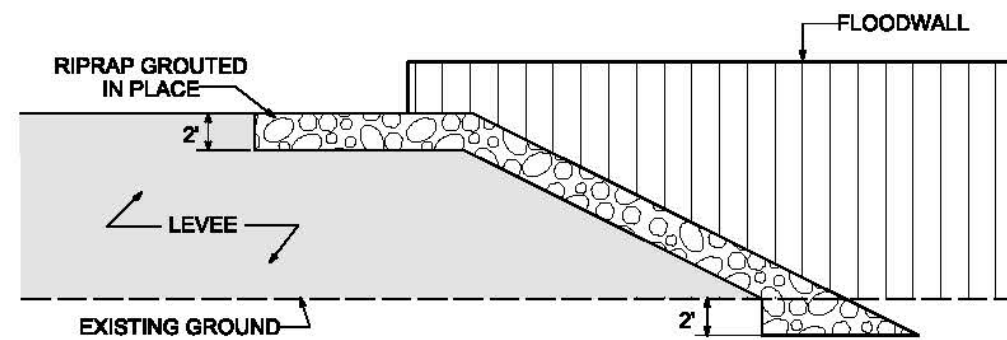

A SECTION
S-01/S-01 N.T.S.

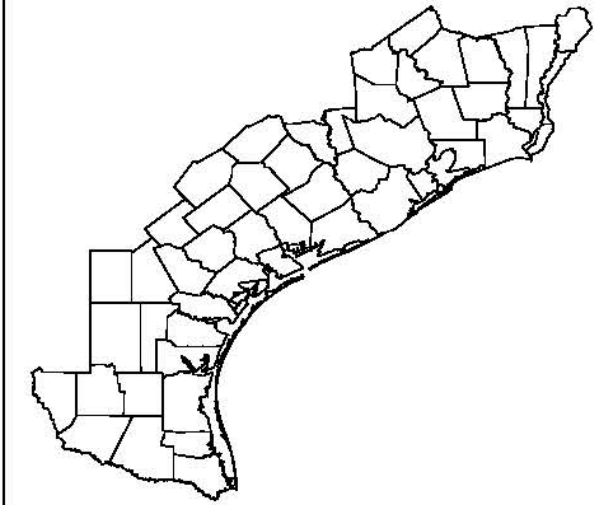

Typical Section S-02

Measures:

- 3-1
- 3-2
- 3-3



This product is reproduced from geospatial information prepared by the U.S. Army Corps of Engineers. GIS data and product accuracy may vary. Data may be developed from sources of differing accuracy, accurate only at certain scales, based on modeling or interpretation, incomplete while being created or revised, etc. Using GIS products for purposes other than those for which they were created may yield inaccurate or misleading results. The Corps of Engineers reserves the right to correct, update, modify, or replace GIS products without notifications.

Date Created: 4/24/2013



Typical Section S-03: Scour Protection

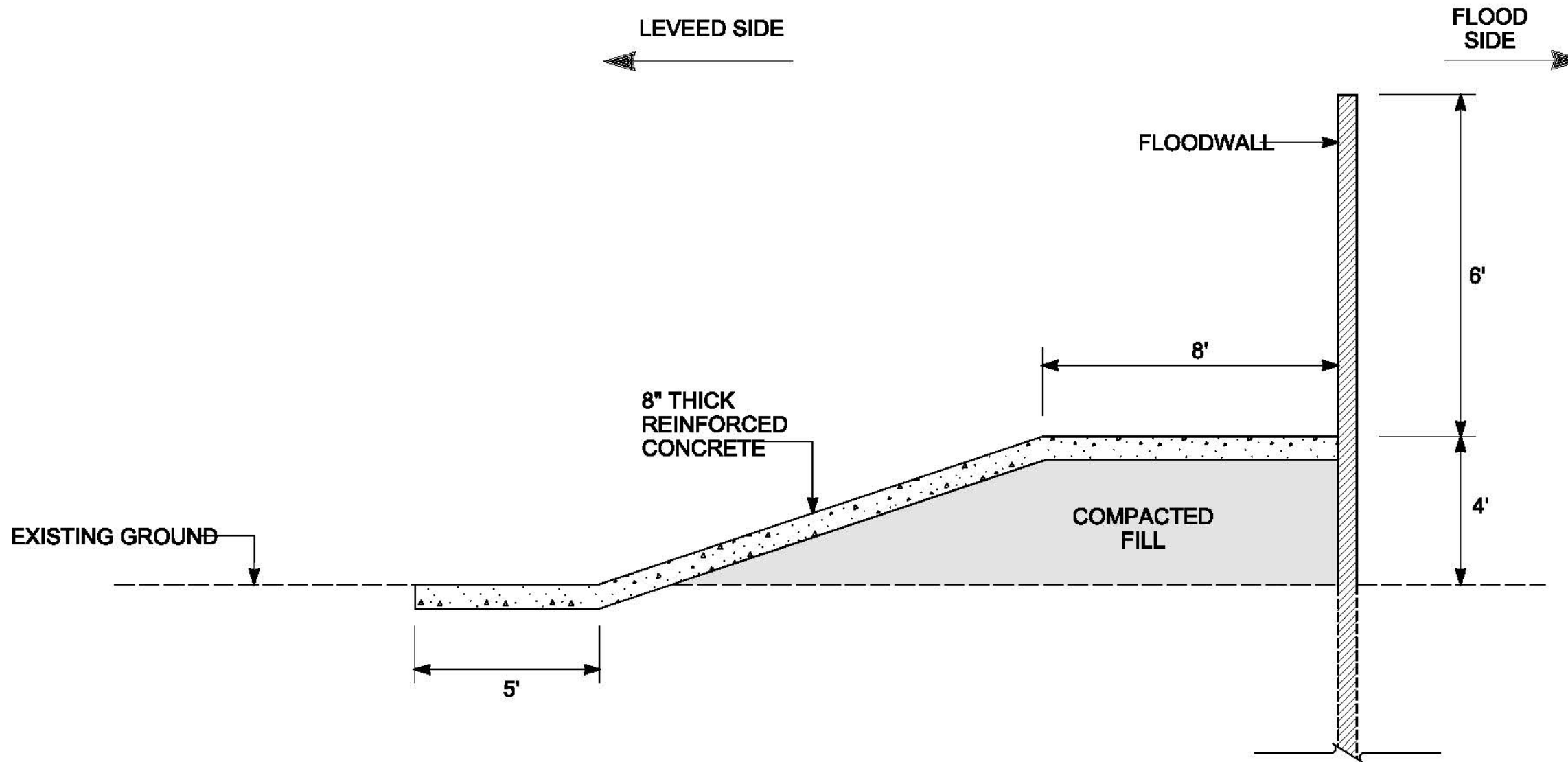

SCOUR PROTECTION

N.T.S.

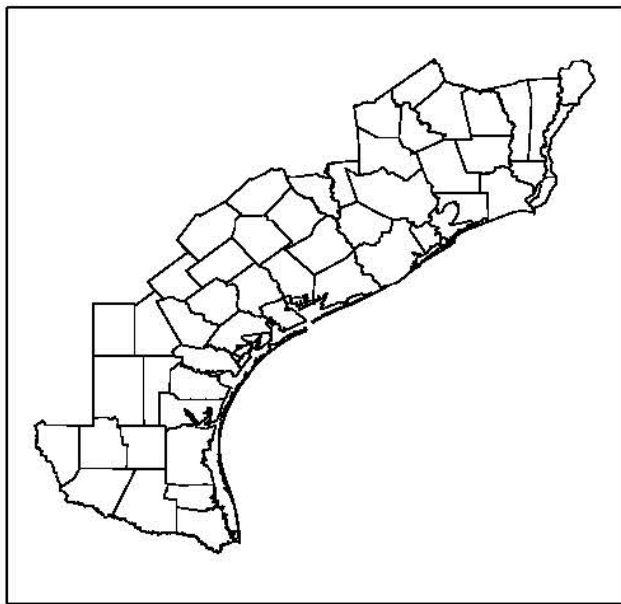

Typical Section S-03

Measures:

- 3-1
- 3-2
- 3-3



This product is reproduced from geospatial information prepared by the U.S. Army Corps of Engineers. GIS data and product accuracy may vary. Data may be developed from sources of differing accuracy, accurate only at certain scales, based on modelling or interpretation, incomplete while being created or revised, etc. Using GIS products for purposes other than those for which they were created may yield inaccurate or misleading results. The Corps of Engineers reserves the right to correct, update, modify, or replace GIS products without notifications.

Date Created: 4/24/2013



U.S. Army Corps of Engineers
BUILDING STRONG

SABINE PASS TO GALVESTON BAY, TEXAS
MEASURES 3-4, 3-5, 3-6, 3-7, and 3-8
INFORMATION SHEET

DESCRIPTION OF MEASURES

The Orange County Economic Development Corporation and the Texas Water Development Board have sponsored a feasibility study of alternatives to address storm surge flooding in Orange County, Texas (see References). The study was initiated in response to severe storm surge damage from Hurricane Ike. These measures address various scales of surge protection, with some limited to Orange County and others encompassing adjacent parts of Jefferson County and Calcasieu Parish, Louisiana.

Measure 3-4 County-Wide Protection System on Sabine River and East Bank of Neches River, Orange County. This measure is an earthen levee/flood wall protection system that would provide full protection to Orange County but would not offer the protection to the cities of Beaumont and Nederland on the west bank of the Neches River. The levee/wall system would start on the east bank of the Sabine River north of Interstate Highway (IH) 10, follow the Sabine River southward to the vicinity of Adams Bayou where it would turn westward, follow the high terrace banks at the confluence of the Sabine-Neches rivers to the Bridge City area, and turn northward following the high terrace of the east bank of the Neches River, terminating at a point north of the IH 10.

Measure 3-5 County-Wide Protection System on the East and West Bank of the Neches River, Orange County and Part of Jefferson County. This measure is an earthen levee/flood wall protection system that would provide full protection to both Orange County and the cities of Beaumont and Nederland, without using a closure structure on the Neches River. This system would connect to the Sabine River-East Bank of Neches River Measure 3-4 near IH 10, follow the west bank of the Neches River to the southeast, and terminate with a connection to the existing Port Arthur levee system.

Measure 3-6 County-Wide Protection System with Neches River Closure and Port Arthur Levee Tie-In, Orange County and Part of Jefferson County. This measure is an earthen levee/flood wall protection system that would provide full protection to both Orange County and the cities of Beaumont and Nederland. It connects the Sabine River levee/floodwall section of Measure 3-4 near Bridge City to a closure structure crossing the mouth of the Neches River and then connects to the existing Port Arthur protection system on the west bank of the Neches River.

Measure 3-7 Sabine River Crossing, Orange County and Calcasieu Parish.

This measure is a closure structure on the Sabine River and a connecting earthen levee protection system that would protect fresh water supplies managed by the Sabine River Authority of Texas. The Sabine River closure structure would tie-in to a segment of Measure 3-4, the east bank Sabine River earthen levee/floodwall system, just south of I10 and a levee would extend eastward to higher ground on the outskirts of Toomey, Louisiana.

Measure 3-8 Orange County Industrial Complex Protection System, Orange County.

This measure is an earthen levee/floodwall system that would protect a concentration of petrochemical industries near West Orange, Texas. This is ring system which would provide an initial level of protection to critical economic infrastructure in Orange County as a possible “first phase” of a county-wide protection system.

LOCATION OF MEASURES (See attached drawings)

Orange County Drawing 3-4.pdf

Measure 3-4: Orange County - County-Wide Protection - East Bank of Neches River.pdf

Orange County Drawing 3-5.pdf

Measure 3-5: Orange County - Protection System on the East and West Bank of the Neches River.pdf

Orange County Drawing 3-6.pdf

Measure 3-6: Orange County - County-Wide Protection with Neches River Crossing.pdf

Orange County Drawing 3-7.pdf

Measure 3-7: Orange County - County-Wide Protection with Neches and Sabine River Crossings.pdf

Orange County Drawing 3-8.pdf

Measure 3-8: Orange County - Industrial Complex Protection System.pdf

DESIGN ASSUMPTIONS

All Measures: Earthen levees would be the main protection system used in each alternative alignment, but flood walls would be used where necessary to limit impacts to adjacent facilities or existing development. Two typical L-wall sections were used to represent the flood wall geometry throughout the proposed alignments, with only the stem height varying to

accommodate variations in natural ground elevations. Footing width, stem thickness, and pile arrangements for the floodwall typical section were based on a stem height of 14' for the larger typical section and 8' for the smaller typical section. All measures would require the installation of pump stations to facilitate removal of water inside the proposed levee systems while the gate structures are closed. Numerous storm water pump stations would need to be constructed with pumping capacity ranging in size from 100,000 gallons per minute to 2,500,000 gallons per minute. The pumps stations would be concrete structures that would provide protection of the equipment during major storm events.

Measures 3-4, 3-5 and 3-6 would require closure of Cow and Adams Bayou. A sector gate with a navigable opening of 56' was selected to represent the navigable structure at Cow Bayou [check for typical plan]. This structure is large enough to accommodate single barges and other moderate draft vessels that are likely to use the waterway. The navigable closure structure at Cow Bayou was modeled after the sector gate recently completed at the Caernarvon Canal as part of the New Orleans Hurricane Protection Project Work. Due to the width of the floodway at the proposed crossing, an additional series of non-navigable flood gates are proposed to mitigate impacts to channel flow during regular upland rainfall events. Two 160 feet wide vertical lift flood gates would flank the sector gate and an additional vertical lift flood gate would be provided in an adjacent oxbow to the south to maximize the flow area available for the passage of flood flows during times of high runoff not associated with a concurrent storm surge. Adams Bayou would be closed with same type of structure as Cow Bayou. A pair of smaller non-navigable vertical lift flood gates would also flank the navigable sector gate.

Measure 3-6 would include a navigable closure structure at the mouth of the Neches River that would allow the river to be closed prior to hurricane landfall but open for navigation and normal flow at all other times. For the purposes of considering feasibility, the Maeslant Barrier in Hoek van Holland, The Netherlands was considered as the model for this closure structure. The Neches River Closure Structure is required to provide protection for surge elevations to a minimum elevation 20.0 feet and a sill elevation of approximately -50.00 feet to accommodate the proposed deepening of the Neches River. Measure 3-6 would also include a non-navigable closure structure to protect operational requirements of the Entergy Intake Canal. A typical flood gate structure is proposed to affect closure of the canal. Six 84" diameter bypass pipes with redundant valves on each would allow flow through the levee system to be controlled as head increased on the outside of the structure during a storm surge. For the purpose of this study, it is assumed that an additional pump station would be included in this measure.

HYDRAULICS & HYDROLOGY

All of the proposed measures provide a higher level of protection than the minimum 100-year recurrence interval required by the Federal Emergency Management Agency (FEMA). Updated and calibrated Advanced Circulation (ADCIRC) modeling of the “worst case” event (for the purposes of the Orange Co EDC study) indicated resulting surge and wave heights considerably higher than the FEMA 100 year elevations. The chosen protection level would more than satisfy FEMA requirements while protecting Orange County from a direct hit from an “Ike level” event. The summary of top elevations utilized for preliminary design and cost estimating purposes is as follows:

- Elevation 19 from tie in to Port Arthur system to Cow Bayou
- Elevation 18 from Cow Bayou to Adams Bayou
- Elevation 16 from Adams Bayou to IH 10
- Elevation 12.5 from IH 10 to approximately 8 miles north of IH 10

The design rainfall event utilized for analysis of the interior drainage systems is the FEMA benchmark 100-year rainfall (1% probability of occurrence). Peak flows were developed for point locations where the interior drainage channels would drain through the proposed structural systems. At these locations, proposed closure structures and pump stations would concurrently provide protection against storm surges and pumping capacity adequate to convey the 100-year runoff that may be associated with a tropical storm or hurricane event.

REAL ESTATE

A detailed breakdown of Real Estate costs can be found in the supplemental document 'Sabine Pass to Galveston Bay, Texas Preliminary Real Estate Cost Estimate'.

- Measure 3-4: County-Wide Protection System on Sabine River and East Bank of Neches River, Orange County
Total Estimated Real Estate Cost of Measure 3-4: \$15,800,000 ®
- Measure 3-5: County-Wide Protection System on the East and West Bank of Neches River, Orange County and Part of Jefferson County
Total Estimated Real Estate Cost of Measure 3-5: \$5,500,000 ®

- Measure 3-6: County-Wide Protection System with Neches River Closure and Port Arthur Levee Tie-In, Orange County and Part of Jefferson County
Total Estimated Real Estate Cost of Measure 3-6: \$463,000 ®
- Measure 3-7: Sabine River Crossing, Orange County and Calcasieu Parish
Total Estimated Real Estate Cost of Measure 3-7: \$580,000 ®
- Measure 3-8: Orange County Industrial Complex Protection System, Orange County
Total Estimated Real Estate Cost of Measure 3-8: \$970,000 ®

ENVIRONMENTAL

These measures would protect dense residential and/or industrial areas in Orange and Jefferson Counties, as well as valuable marsh, swamp and bottomland hardwood wetland systems. The levee/floodwall systems would protect these areas from the adverse effects of surge scouring and salinity insults. Very large marsh systems on the Neches River would be protected by Measures 3-4 and 3-5, including the Lower Neches Wildlife Management Area (WMA) (Nelda Stark, Old River Cove, and Adam Bayou units). Extensive fresh swamp and bottomland hardwood systems would be protected by Measures 3-6 and 3-7, including the Blue Elbow and Sabine Island WMAs. Environmental benefits are presented in wetland acres that would be protected by these measures. The wetland acres were calculated with a GIS analysis of National Wetland Inventory wetland maps (USFWS, 2012). The benefits for each measure are presented in the table below:

Measure Number and Location	Forested or Emergent Marsh Wetlands (acres)
Measure 3-4 (County-Wide Protection System on Sabine River and East Bank of Neches River)	7,000
Measure 3-5 (County-Wide Protection System on the East and West Banks of the Neches River)	7,400
Measure 3-6 (County-Wide Protection System with Neches River Closure and Port Arthur Levee Tie-In)	31,500
Measure 3-7 (Sabine River Crossing)	37,000
Measure 3-8 (Orange County Industrial Complex Protection System)	650

BENEFITS

With and without project damages to structures, contents, and vehicles were calculated using HEC-FIA (Flood Impact Analysis) software package which analyzes consequences for a given flood event, in this case, a 1% annual exceedance probability (100-year). Without project damages are those that would occur under the current existing condition. Residual damages are those that would occur with a given measure in place. Benefits are the difference between the two. These numbers are listed in the tables below.

This economic analysis does not take into account losses of human life or impacts to the economy of the region that would result from economic and industrial disruptions caused by storm surge. It could take weeks to get critical petro-chemical facilities back on-line, and months to clean-up and fully repair flooded facilities. The lives of thousands of people would be disrupted until homes could be rebuilt, and temporary dislocations would adversely affect employers who would lose employees as they relocate to other areas.

Storm Surge Regions

Region	Counties
6	Brazoria, Galveston, Harris
7	Chambers, Galveston, Harris, Jefferson
8	Chambers, Jefferson, Orange

Benefits for Measures 3-4 to 3-8

Measure 3-4: County-Wide Protection System on Sabine River and East Bank of Neches River, Orange County			Region 8
	Without Project Damages	Residual Damages	Benefits
Structure	\$1,041,712,000	\$429,098,000	\$612,614,000
Contents	\$1,078,037,000	\$419,311,000	\$658,726,000
Vehicles	\$362,768,000	\$141,784,000	\$220,984,000
Total	\$2,482,517,000	\$990,193,000	\$1,492,324,000

Measure 3-5: County-Wide Protection System on the East and West Bank of the Neches River, Orange County and Part of Jefferson County			Region 8
	Without Project Damages	Residual Damages	Benefits
Structure	\$1,041,712,000	\$408,787,000	\$632,925,000
Contents	\$1,078,037,000	\$402,144,000	\$675,893,000
Vehicles	\$362,768,000	\$136,033,000	\$226,735,000
Total	\$2,482,517,000	\$946,964,000	\$1,535,553,000

Measure 3-6: County-Wide Protection System with Neches River Closure and Port Arthur Levee Tie-In, Orange County and Part of Jefferson County			Region 8
	Without Project Damages	Residual Damages	Benefits
Structure	\$1,041,712,000	\$279,588,000	\$762,124,000
Contents	\$1,078,037,000	\$262,179,000	\$815,858,000
Vehicles	\$362,768,000	\$91,196,000	\$271,572,000
Total	\$2,482,517,000	\$632,963,000	\$1,849,554,000

Measure 3-7: Sabine River Crossing, Orange County and Calcasieu Parish			Region 8
	Without Project Damages	Residual Damages	Benefits
Structure	\$1,041,712,000	\$266,386,000	\$775,326,000
Contents	\$1,078,037,000	\$258,190,000	\$819,847,000
Vehicles	\$362,768,000	\$88,151,000	\$274,617,000
Total	\$2,482,517,000	\$612,727,000	\$1,869,790,000

Measure 3-8: Orange County Industrial Complex Protection System, Orange County			Region 8
	Without Project Damages	Residual Damages	Benefits
Structure	\$1,041,712,000	\$994,875,000	\$46,837,000
Contents	\$1,078,037,000	\$1,024,728,000	\$53,309,000
Vehicles	\$362,768,000	\$347,910,000	\$14,858,000
Total	\$2,482,517,000	\$2,367,513,000	\$115,004,000

COSTS

Cost for these measures were derived from the Orange County Report (see reference below).

Measure 3-4: The estimated cost for this measure is \$ 1,472,000,000.

Measure 3-5: The estimated cost for this measure is \$1,738,000,000.

Measure 3-6: The estimated cost for this measure is \$ 1,549,000,000.

Measure 3-7: The estimated cost for this measure is \$ 1,842,000,000.

Measure 3-8: The estimated cost for this measure is \$ 212,000,000.

REFERENCE DOCUMENTS

The cost, drawings, gates, I walls and levee designs developed in the report “Flood Protection Planning Study Hurricane Flood Protection System Orange County, Texas,” Final Report dated August 2012, were used for this measure. The report was prepared for the Orange County Economic Development Corporation and Texas Water Development Board by Carroll and Blackman, Inc, Costello, Inc., and LJA Engineers, Inc. A copy of the Orange County Report with appendices can be found on SharePoint: <https://extranet.dse.usace.army.mil/sites/Divisions/SWD/SWG/S2G/default.aspx>.

U.S. Fish and Wildlife Service (USFWS). 2012. National Wetland Inventory. Accessed on the internet at <http://www.fws.gov/wetlands/Data/Mapper.html> .

RISKS:

- Geotechnical and Structural feasibility of the proposal was not reviewed by the COE.
- No review of available public information or data from in-house files relative to the general geology and soil conditions for the proposed features was conducted.
- System configuration and the proposed structures were not assessed by the COE.
- Project design would need to include the development and calibration of a hydrologic and hydraulic model of the Neches River which would allow development of various hydrographs at the location of the proposed Neches River gate structure.
- This environmental analysis does not take into account environmental impacts that would occur without the surge protection system as a result of contaminant spills from the high number of petro-chemical plants and other industrial facilities in these areas.
- Existing surge runs are available for the with-project condition performed by others but were not utilized for this stage of analysis. These would have to be examined during future phases of the study if this measure goes forward.
- There could be an increase in surge where the levee/floodwall system end and fully understanding this consequence should involve ADCIRC modeling.
- Modeling is needed to evaluate the effect of overtopping of the system in case a larger storm than the 100-year occurs. If water gets trapped behind the surge protection systems, there could be significant consequences.

Measure 3-4: County-Wide Protection on Sabine River and East Bank of Neches River, Orange County

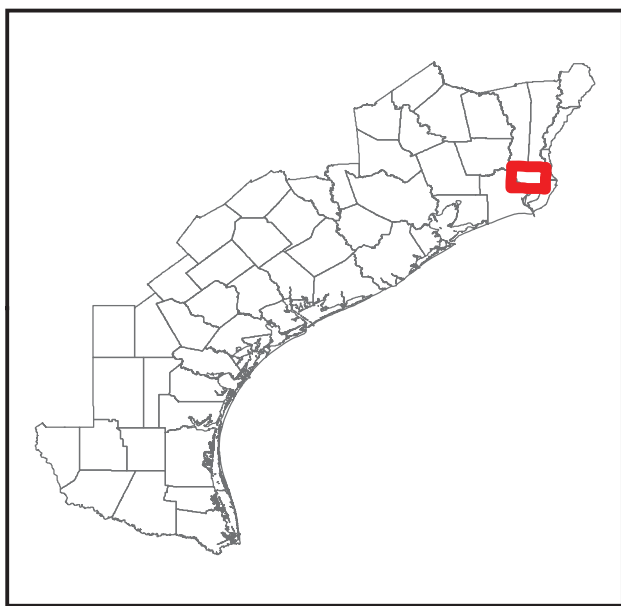
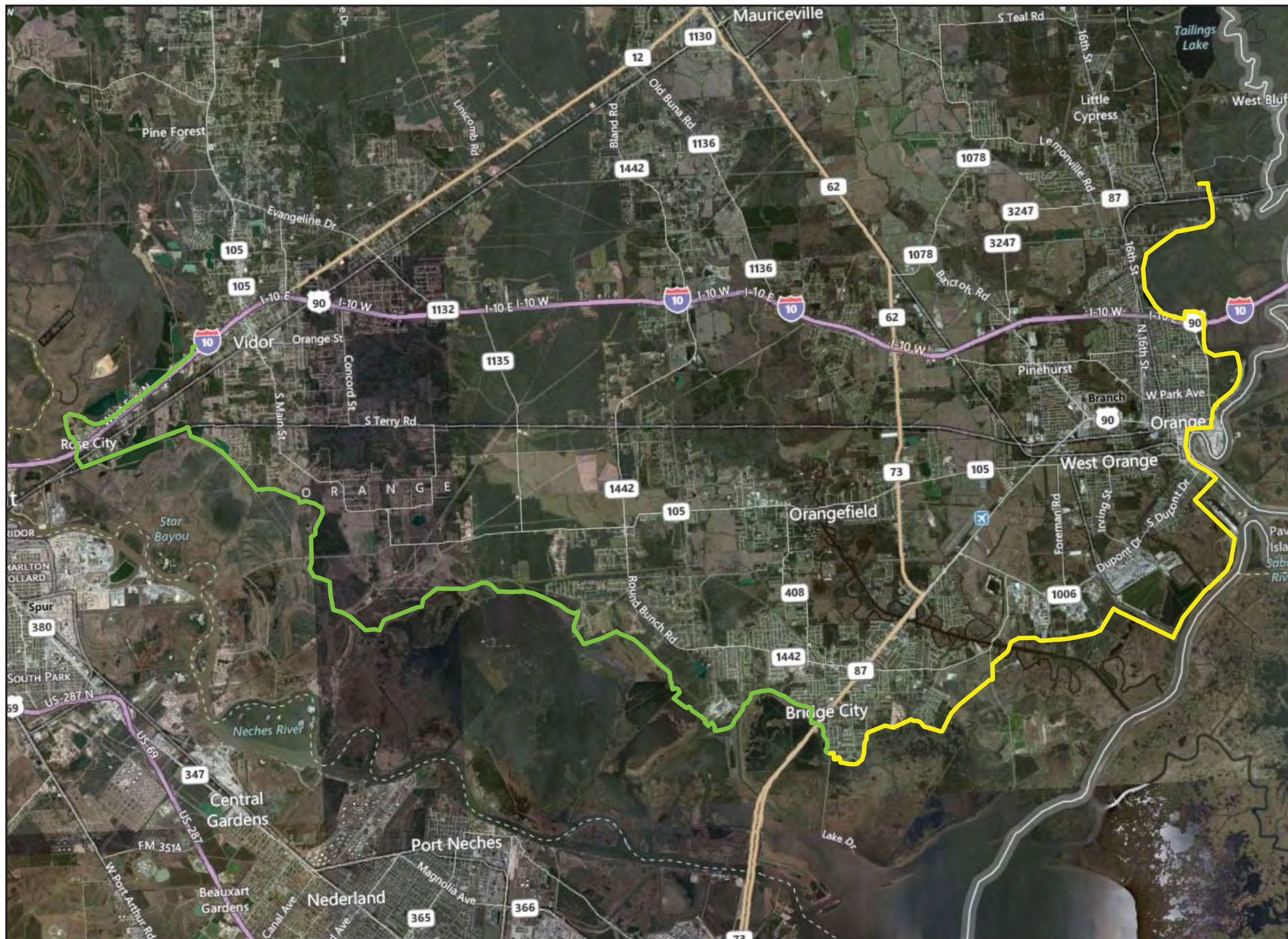

Legend

- Neches River Levee
- Sabine River Levee

0 3,100 6,200 12,400 18,600 24,800
 Feet

This product is reproduced from geospatial information prepared by the U.S. Army Corps of Engineers. GIS data and product accuracy may vary. Data may be developed from sources of differing accuracy, accurate only at certain scales, based on modeling or interpretation, incomplete while being created or revised, etc. Using GIS products for purposes other than those for which they were created may yield inaccurate or misleading results. The Corps of Engineers reserves the right to correct, update, modify, or replace GIS products without notifications.

Sabine Pass to Galveston Bay Texas, Coastal Storm Risk Management and Ecosystem Restoration Feasibility Study

Measure 3-5: County-Wide Protection System on East and West Bank of the Neches River, Orange County and Part of Jefferson County

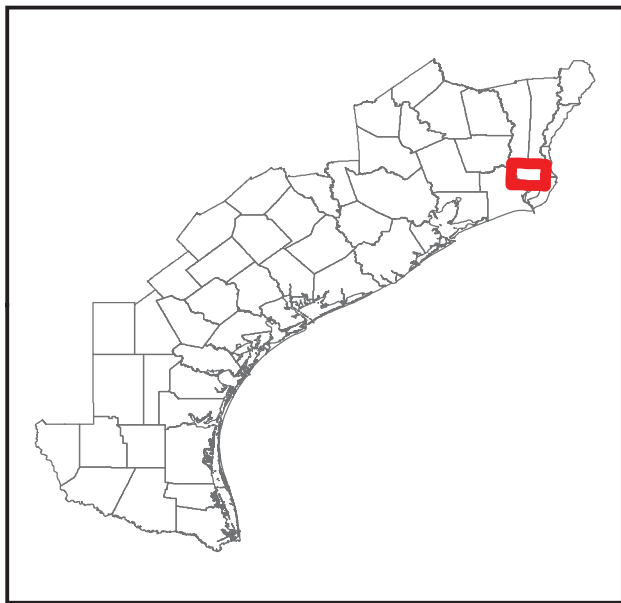
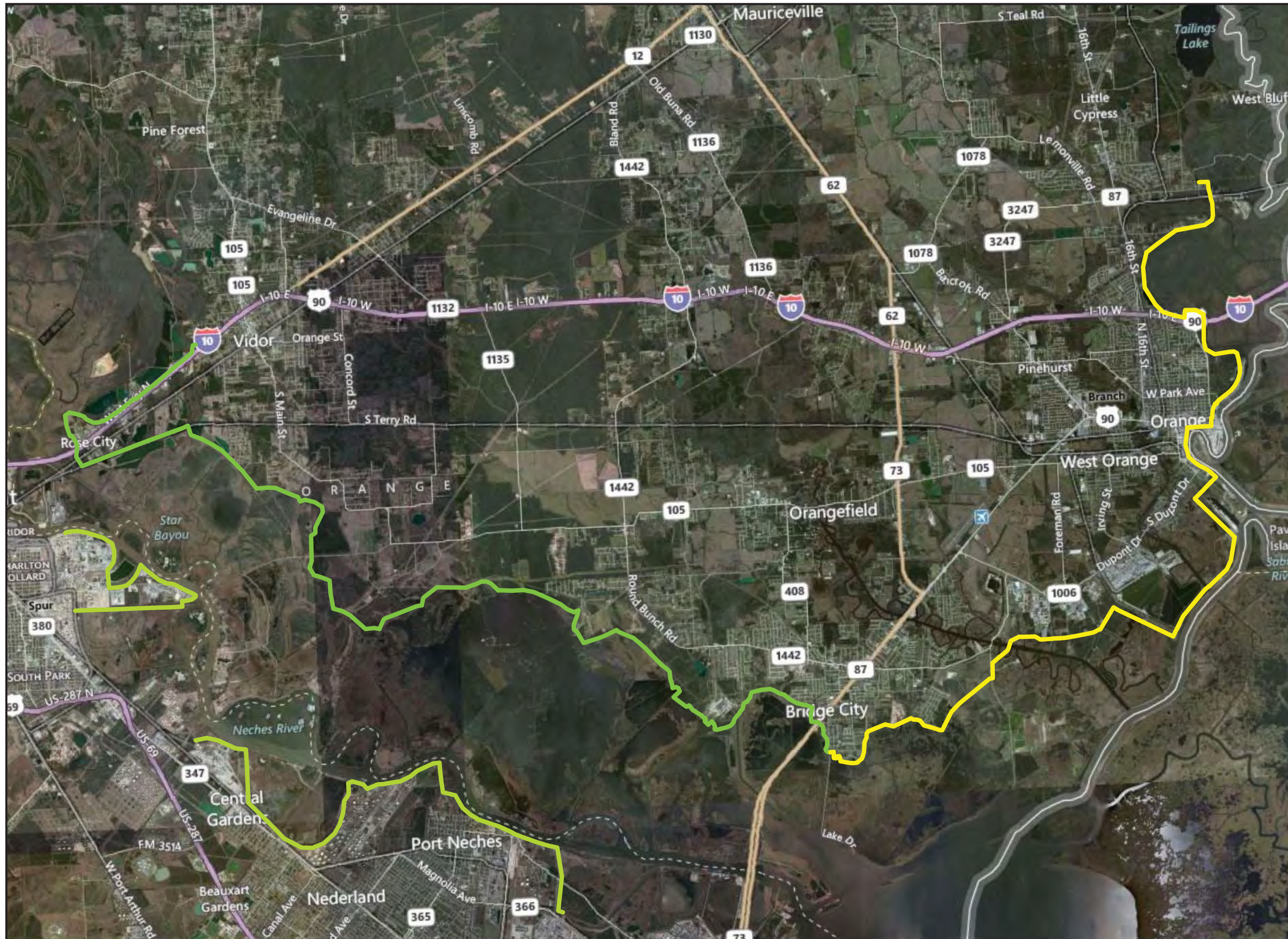

Legend

- Neches River Levee (West)
- Neches River Levee (East)
- Sabine River Levee





0 3,100 6,200 12,400 18,600 24,800 Feet

This product is reproduced from geospatial information prepared by the U.S. Army Corps of Engineers. GIS data and product accuracy may vary. Data may be developed from sources of differing accuracy, accurate only at certain scales, based on modeling or interpretation, incomplete while being created or revised, etc. Using GIS products for purposes other than those for which they were created may yield inaccurate or misleading results. The Corps of Engineers reserves the right to correct, update, modify, or replace GIS products without notifications.

Date Created: 4/24/2013



Sabine Pass to Galveston Bay Texas, Coastal Storm Risk Management and Ecosystem Restoration Feasibility Study

Measure 3-6: County-Wide Protection System with Neches River Closure and Port Arthur Levee Tie-In, Orange County and Part of Jefferson County

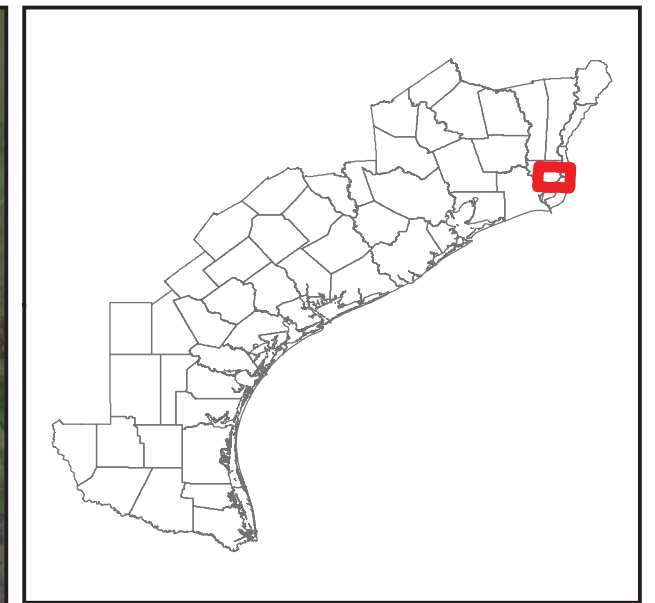

Legend

- Neches River Crossing
- Sabine River Levee

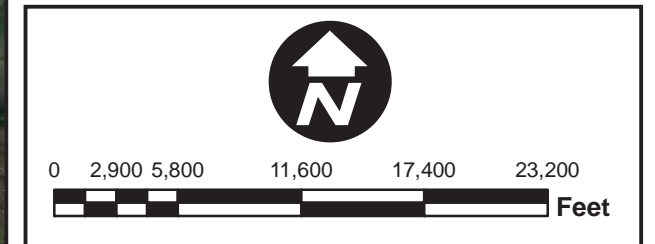

This product is reproduced from geospatial information prepared by the U.S. Army Corps of Engineers. GIS data and product accuracy may vary. Data may be developed from sources of differing accuracy, accurate only at certain scales, based on modeling or interpretation, incomplete while being created or revised, etc. Using GIS products for purposes other than those for which they were created may yield inaccurate or misleading results. The Corps of Engineers reserves the right to correct, update, modify, or replace GIS products without notifications.

Measure 3-7: Sabine River Crossing, Orange County and Calcasieu Parish

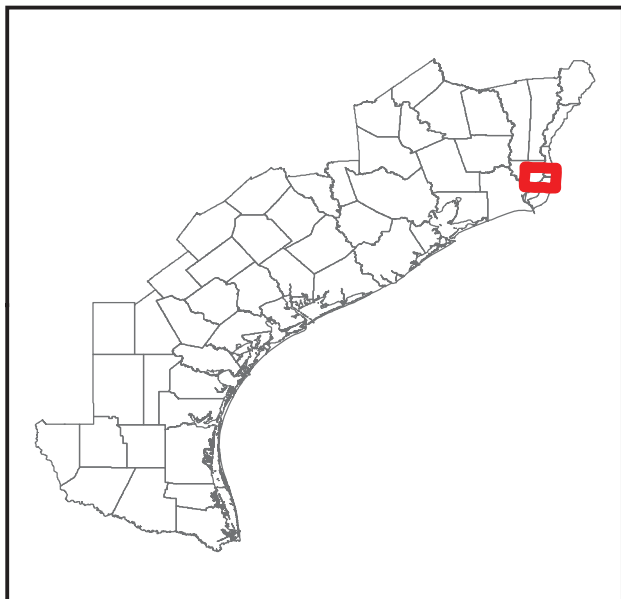
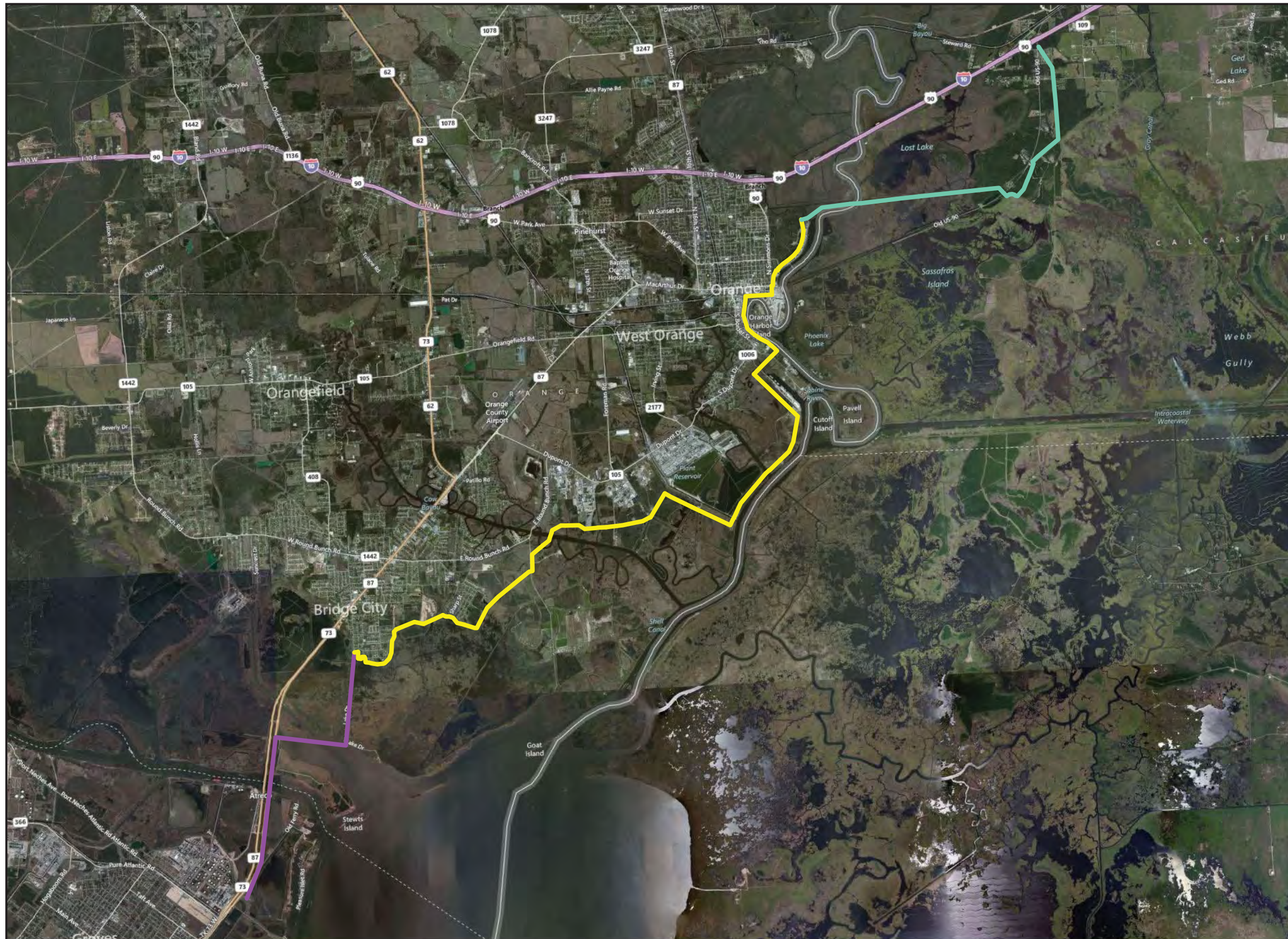

- Legend**
- Neches River Crossing
 - Sabine River Crossing
 - Sabine River Levee

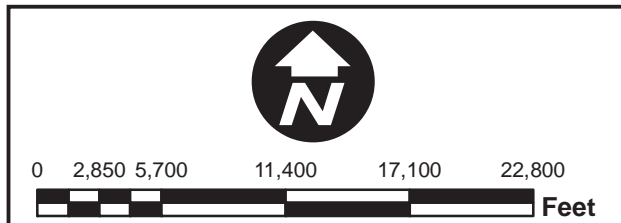

This product is reproduced from geospatial information prepared by the U.S. Army Corps of Engineers. GIS data and product accuracy may vary. Data may be developed from sources of differing accuracy, accurate only at certain scales, based on modeling or interpretation, incomplete while being created or revised, etc. Using GIS products for purposes other than those for which they were created may yield inaccurate or misleading results. The Corps of Engineers reserves the right to correct, update, modify, or replace GIS products without notifications.

Measure 3-8: Orange County Industrial Complex Protection System, Orange County



Legend

— Industry Levee

This product is reproduced from geospatial information prepared by the U.S. Army Corps of Engineers. GIS data and product accuracy may vary. Data may be developed from sources of differing accuracy, accurate only at certain scales, based on modeling or interpretation, incomplete while being created or revised, etc. Using GIS products for purposes other than those for which they were created may yield inaccurate or misleading results. The Corps of Engineers reserves the right to correct, update, modify, or replace GIS products without notifications.

SABINE PASS TO GALVESTON BAY, TEXAS
MEASURES 3-9, 3-10.1, 3-10.2, 3-10.3, 3-10.4, 3-10.5 and 3-10.6
INFORMATION SHEET

DESCRIPTION OF MEASURES

This group of measures would provide storm surge protection to localized areas with dense concentrations of population, petro-chemical industries or nationally significant public facilities.

Measure 3-9 Galveston Ring Levee, Galveston County: This measure would consist of the construction of a new ring levee and floodwall system around the bay side of east Galveston Island, tying into each end of the Seawall. This system would provide protection for the city of Galveston behind the Seawall when hurricane-force winds are blowing from the north. The levee alignment would extend from the east end terminus of the Seawall around the San Jacinto Placement Area to Harborside Drive, and along the Island's north side (or bay side) until Offatts Bayou. From Offatts Bayou a levee would extend parallel to 103rd street until it meets the west end of the Seawall. Approximately 7.8 miles of earthen embankment and 4.9 miles of floodwall would be required for this measure, with two navigation structures, one at Laguna de Oro and a second, larger structure with circulation gates at Offatts Bayou.

Measures 3-10 Various Local Surge Protection Measures: These measures would provide localized surge protection to industrial areas on the Houston Ship Channel (HSC), or at job centers like NASA and UTMB.

Measure 3-10.1 Local Surge Protection, Houston Ship Channel North, Harris County. This measure would provide protection to the portion of Harris County north of the Buffalo Bayou reach of the HSC through the construction of a surge protection system of levees and floodwalls.

Measure 3-10.2 Local Surge Protection, Houston Ship Channel South, Harris County. This measure would provide protection to the portion of Harris County south of the Buffalo Bayou reach of the HSC through the construction of a surge protection system of levees and floodwalls.

Measure 3-10.3 Local Surge Protection, Baytown, Harris County. This measure would provide protection to a concentration of petro-chemical plants in the city of Baytown, east of the HSC and just north of the Fred Harman Bridge, through the construction of a surge protection system of levees and floodwalls.

3-10.4 Local Surge Protection, NASA, Harris County. This measure would provide protection to NASA’s Johnson Space Center on the north shore of Clear Lake through the construction of a surge protection system of levees and floodwalls.

Measure 3-10.5 Local Surge Protection, UTMB, Galveston County. This measure would provide protection to the complex of hospitals and research facilities around the University of Texas Medical Branch on Galveston Island through the construction of a surge protection system of levees and floodwalls.

Measure 3-10.6 Local Surge Protection, Chocolate Bayou, Brazoria County. This measure would provide protection to a concentration of petro-chemical plants located on Chocolate Bayou through the construction of a surge protection system of levees and floodwalls.

LOCATION OF MEASURES (see referenced maps)

Measure 3-9: Local Surge Protection, Galveston Ring Levee

Measure 3-10.1: Local Surge Protection, Houston Ship Channel North, Harris County.

Measure 3-10.2: Local Surge Protection, Houston Ship Channel South, Harris County.

Measure 3-10.3: Local Surge Protection, Baytown, Harris County.

Measure 3-10.4: Local Surge Protection, NASA, Harris County.

Measure 3-10.5: Local Surge Protection, UTMB, Galveston County.

Measure 3-10.6: Local Surge Protection, Chocolate Bayou, Brazoria County.

DESIGN ASSUMPTIONS

Measure 3-9:

- Levee and floodwall locations and lengths estimated using heads-up digitizing on ArcGIS.
- Approximately 7.8 miles of levees estimated.
- Approximately 4.9 miles of floodwall estimated.
- Two 300 ft lift gate type navigation structures will be required. See Applying best practices (Ike Dike) report for details (pg. 21 Barge Lift Gate est. \$30 mil).

Measure 3-10 (all)

- Levee and floodwall heights assumed to be 20 feet.

- Levee and floodwall locations and lengths estimated using heads-up digitizing on ArcGIS.
- Alignment was selected to encompass critical infrastructure/industry

MEASURE	LEVEE (MILES)	FLOODWALL (MILE)
3-10.1	8.2	16.1
3-10.2	10.4	16.0
3-10.3	0.6	6.9
3-10.4	5.6	0.0
3-10.5	0.0	1.9
3-10.6	13.4	0.0

HYDRAULICS & HYDROLOGY

The design storm used for the H&H analysis is the 100-year storm surge derived by FEMA using results from the FEMA 2011 Texas Coastal Counties Study. The ADCIRC results from the FEMA study were converted into a without-project 100 year flood depth grid that corresponds to existing conditions. Chosen protection would satisfy FEMA requirements while protecting the evaluated areas from the 100-year surge levels. A summary of top elevations utilized for preliminary design and cost estimating purposes is listed below.

- Measure 3-9: Elevation 19 tying into the west side of the seawall, Elevation 17 tying into the right side of the seawall, providing protection to the Bay Side of Galveston Island
- Measures 3-10.1 and 3-10.2: Elevation 18 for measures providing protection to portions of Harris County North and Harris County South of the Buffalo Bayou Reach of the HSC
- Measure 3-10-3: Elevation 19 for measure providing protection to protecting petro-chemical plants and Baytown
- Measure 3-10.4: Elevation 20 for measure providing protection to NASA’s space center on the northern shore of Clear Lake.
- Measure 3-10.5: Elevation 12 for measure protecting UTMB with levee and floodwall systems
- Measure 3-10.6: Elevation 15 for measure protecting concentration of petro-chemical plants located on Chocolate Bayou.

The design rainfall event utilized for analysis of the interior drainage systems is the FEMA benchmark 100-year rainfall (1% probability of occurrence). Peak flows were developed for point locations where the interior drainage channels would drain through the proposed structural

systems. At these locations, proposed closure structures and pump stations would concurrently provide protection against storm surges and pumping capacity adequate to convey the 100-year runoff that may be associated with a tropical storm or hurricane event.

REAL ESTATE

A detailed breakdown of Real Estate costs can be found in the supplemental document 'Sabine Pass to Galveston Bay, Texas Preliminary Real Estate Cost Estimate'. Costs identified as \$0 are generally associated with Federal and/or State lands.

- Measure 3-9: Galveston Ring Levee, Galveston County
Total Estimated Real Estate Cost: \$95,700,000 ®

- Measure 3-10.1: Local Surge Protection, Houston Ship Channel North, Harris County
Total Estimated Real Estate Cost: \$297,700,000 ®

- Measure 3-10.2: Local Surge Protection, Houston Ship Channel South, Harris County
Total Estimated Real Estate Cost: \$343,700,000 ®

- Measure 3-10.3: Local Surge Protection, Baytown, Harris County
Total Estimated Real Estate Cost: \$37,400,000 ®

- Measure 3-10.4: Local Surge Protection, NASA, Harris County
Total Estimated Real Estate Cost: \$0

- Measure 3-10.5: Local Surge Protection, UTMB, Galveston County
Total Estimated Real Estate Cost: \$8,800,000 ®

- Measure 3-10.6: Local Surge Protection, Chocolate Bayou, Brazoria County
Total Estimated Real Estate Cost: \$19,800,000 ®

ENVIRONMENTAL

These measures would protect dense residential and/or industrial areas in Harris, Galveston and Brazoria Counties; some of which contain patches of forested or emergent marsh wetlands. The levee/floodwall systems would protect these areas from the adverse effects of surge scouring and salinity insults. Environmental benefits are presented in wetland acres that would be protected by these measures. The wetland acres were calculated with a GIS analysis of National Wetland

Inventory wetland maps (USFWS, 2012). The benefits for each measure are presented in the table below:

Measure Number and Location	Forested or Emergent Marsh Wetlands (acres)
Measure 3-9 (Galveston Ring Levee)	300
Measure 3-10.1(Houston Ship Channel North)	2,000
Measure 3-10.2 (Houston Ship Channel South)	400
Measure 3-10.3 (Baytown)	6
Measure 3-10.4 (NASA)	20
Measure 3-10.5 (UTMB)	0
Measure 3-10.6 (Chocolate Bayou)	125

BENEFITS

With and without project damages to structures, contents, and vehicles were calculated using HEC-FIA (Flood Impact Analysis) software package which analyzes consequences for a given flood event, in this case, a 1% annual exceedance probability (100-year). Without project damages are those that would occur under the current existing condition. Residual damages are those that would occur with a given measure in place. Benefits are the difference between the two. These numbers are listed in the tables below.

This economic analysis does not take into account losses of human life or impacts to the economy of the region that would result from economic and industrial disruptions caused by storm surge. It could take weeks to get critical petro-chemical facilities back on-line, and months to clean-up and fully repair flooded facilities. Peoples lives would be disrupted until homes could be rebuilt, and temporary dislocations would adversely effect employers who would loose employees as they relocate to other areas.

Storm Surge Regions

Region	Counties
6	Brazoria, Galveston, Harris
7	Chambers, Galveston, Harris, Jefferson
8	Chambers, Jefferson, Orange

Benefits for Measures 3-9 and 3-10 (all)

Measure 3-9: Galveston Ring Levee, Galveston County			Region 6
	Without Project Damages	Residual Damages	Benefits
Structure	\$5,630,895,000	\$4,324,479,000	\$1,306,416,000
Contents	\$5,854,589,000	\$4,258,977,000	\$1,595,612,000
Vehicles	\$1,337,005,000	\$942,738,000	\$394,267,000
Total	\$12,822,489,000	\$9,526,194,000	\$3,296,295,000

Measure 3-10.1: Local Surge Protection, Houston Ship Channel North, Harris County			Region 6
	Without Project Damages	Residual Damages	Benefits
Structure	\$5,630,895,000	\$5,347,035,000	\$283,860,000
Contents	\$5,854,589,000	\$5,569,207,000	\$285,382,000
Vehicles	\$1,337,005,000	\$1,281,425,000	\$55,580,000
Total	\$12,822,489,000	\$12,197,667,000	\$624,822,000

Measure 3-10.2: Local Surge Protection, Houston Ship Channel South, Harris County			Region 6
	Without Project Damages	Residual Damages	Benefits
Structure	\$5,630,895,000	\$5,158,924,000	\$471,971,000
Contents	\$5,854,589,000	\$5,349,514,000	\$505,075,000
Vehicles	\$1,337,005,000	\$1,224,727,000	\$112,278,000
Total	\$12,822,489,000	\$11,733,165,000	\$1,089,324,000

Measure 3-10.3: Local Surge Protection, Baytown, Harris County			Region 7
	Without Project Damages	Residual Damages	Benefits
Structure	\$1,016,448,000	\$1,015,759,000	\$689,000
Contents	\$833,516,000	\$832,015,000	\$1,501,000
Vehicles	\$252,516,000	\$252,338,000	\$178,000
Total	\$2,102,480,000	\$2,100,112,000	\$2,368,000

Measure 3-10.4: Local Surge Protection, NASA, Harris County			Region 6
	Without Project Damages	Residual Damages	Benefits
Structure	\$5,630,895,000	\$5,627,126,000	\$3,769,000
Contents	\$5,854,589,000	\$5,843,933,000	\$10,656,000
Vehicles	\$1,337,005,000	\$1,336,154,000	\$851,000
Total	\$12,822,489,000	\$12,807,213,000	\$15,276,000

Measure 3-10.5: Local Surge Protection, UTMB, Galveston County			Region 6
	Without Project Damages	Residual Damages	Benefits
Structure	\$5,630,895,000	\$5,622,522,000	\$8,373,000
Contents	\$5,854,589,000	\$5,829,737,000	\$24,852,000
Vehicles	\$1,337,005,000	\$1,335,398,000	\$1,607,000
Total	\$12,822,489,000	\$12,787,657,000	\$34,832,000

Measure 3-10.6: Local Surge Protection, Chocolate Bayou, Brazoria County			Region 6
	Without Project Damages	Residual Damages	Benefits
Structure	\$5,630,895,000	\$5,628,258,000	\$2,637,000
Contents	\$5,854,589,000	\$5,852,936,000	\$1,653,000
Vehicles	\$1,337,005,000	\$1,336,186,000	\$819,000
Total	\$12,822,489,000	\$12,817,380,000	\$5,109,000

COSTS

Costs do not include Real Estate.

Measure 3-9: The estimated cost for this measure is \$460,416,000.

Measure 3-10.1: The estimated cost for this measure is \$863,607,000

Measure 3-10.2: The estimated cost for this measure is \$924,206,000

Measure 3-10.3: The estimated cost for this measure is \$290,145,000

Measure 3-10.4: The estimated cost for this measure is \$154,571,000

Measure 3-10.5: The estimated cost for this measure is \$76,861,000

Measure 3-10.6: The estimated cost for this measure is \$373,197,000

Cost for gates and embankment levee were estimated using costs from the Orange County Study (see reference below). Cost for the floodwall were obtained from New Orleans District for a similar design.

REFERENCE DOCUMENTS

1979 USACE report;

USACE Texas Coast Hurricane Study Feasibility Report.

“Flood Protection Planning Study Hurricane Flood Protection System Orange County, Texas,” Final Report dated August 2012, A copy of the Orange County Report with eight appendices can be found on SharePoint:

<https://extranet.dse.usace.army.mil/sites/Divisions/SWD/SWG/S2G/default.aspx>

Applying best practices from the Delta Works and New Orleans to Galveston Bay, Prepared by: Kasper Stoeten, Master Student Hydraulic Engineering, Delft University of Technology, November 2012 where used. A copy of this report with eight appendices can be found on SharePoint:

<https://extranet.dse.usace.army.mil/sites/Divisions/SWD/SWG/S2G/default.aspx>

U.S. Fish and Wildlife Service. 2012. National Wetland Inventory. Accessed on the internet at <http://www.fws.gov/wetlands/Data/Mapper.html>

RISKS

Measure 3-9

- Geotechnical and Structural feasibility of the proposed was not studied.
- No review of available public information or data from in-house files relative to the general geology and soil conditions along the proposed alignments was conducted.
- Estimated alignment was obtained from USACE Texas Coast Hurricane Study Feasibility Report.
- Cross sections and cost associated with embankment and gates taken from Orange County Flood Protection Planning Study (December 2012).
- Floodwall cost were obtained from MVN for similar design.
- Modeling is needed to evaluate the effect of overtopping of the system in case a larger storm than the 100-year occurs. If water gets trapped behind the surge protection system, there could be significant consequences.

Measure 3-10 (all)

- Alignment was selected to encompass critical infrastructure/industry.
- Geotechnical and Structural feasibility of the proposed was not studied.
- No review of available public information or data from in-house files relative to the general geology and soil conditions along the proposed alignments was conducted.
- Cross sections and cost associated with embankment and gates taken from Orange County Flood Protection Planning Study (December 2012).
- Floodwall cost were obtained from MVN for similar design.
- This environmental analysis does not take into account environmental impacts that would occur without the surge protection system as a result of contaminant spills from the high number of petro-chemical plants and other industrial facilities on the Houston Ship Channel and in the Barbour's Cut and Bayport areas.

- Modeling is needed to evaluate the effect of overtopping of the system in case a larger storm than the 100-year occurs. If water gets trapped behind the surge protection system, there could be significant consequences.

Measure 3-9: Galveston Ring Levee, Galveston County

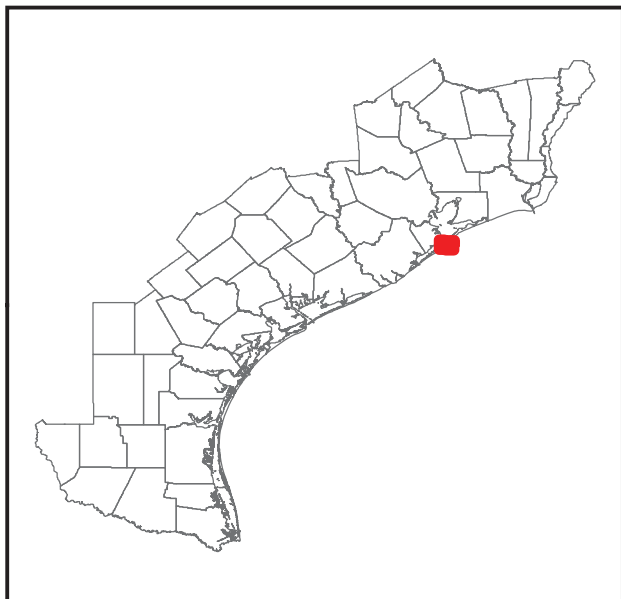
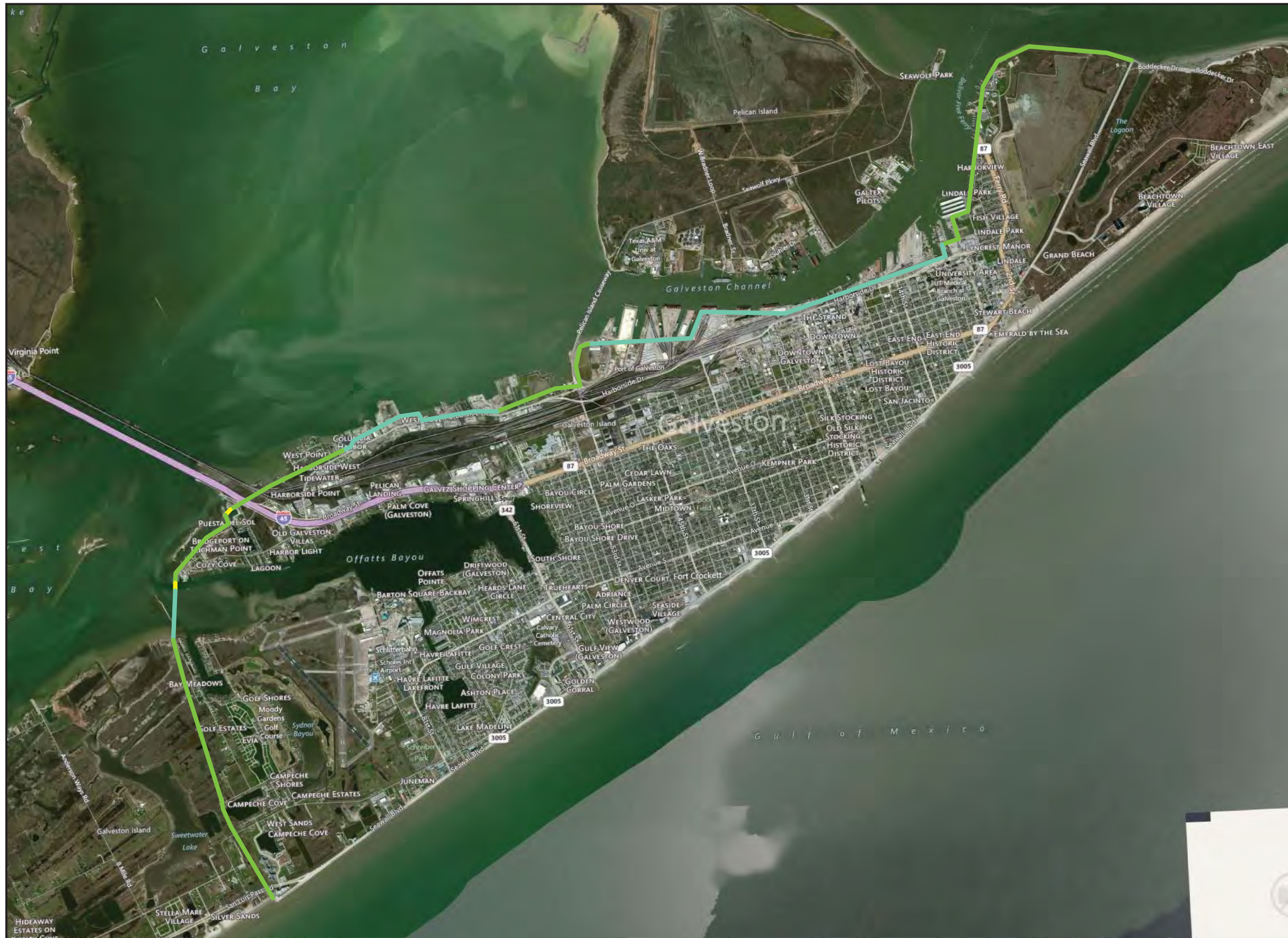

Legend

- █ Levee Embankment
- █ Floodwall
- █ Navigation Gate



This product is reproduced from geospatial information prepared by the U.S. Army Corps of Engineers. GIS data and product accuracy may vary. Data may be developed from sources of differing accuracy, accurate only at certain scales, based on modeling or interpretation, incomplete while being created or revised, etc. Using GIS products for purposes other than those for which they were created may yield inaccurate or misleading results. The Corps of Engineers reserves the right to correct, update, modify, or replace GIS products without notifications.

Date Created: 4/24/2013



Measure 3-10.1: Local Surge Protection, Houston Ship Channel North, Harris County

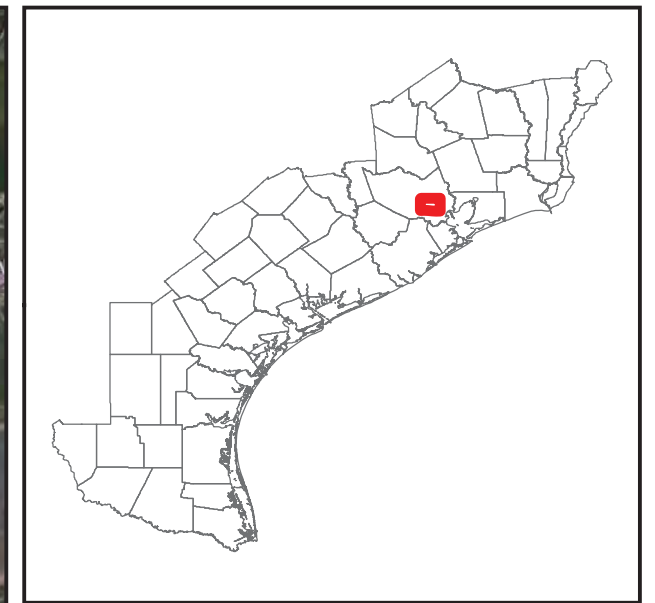
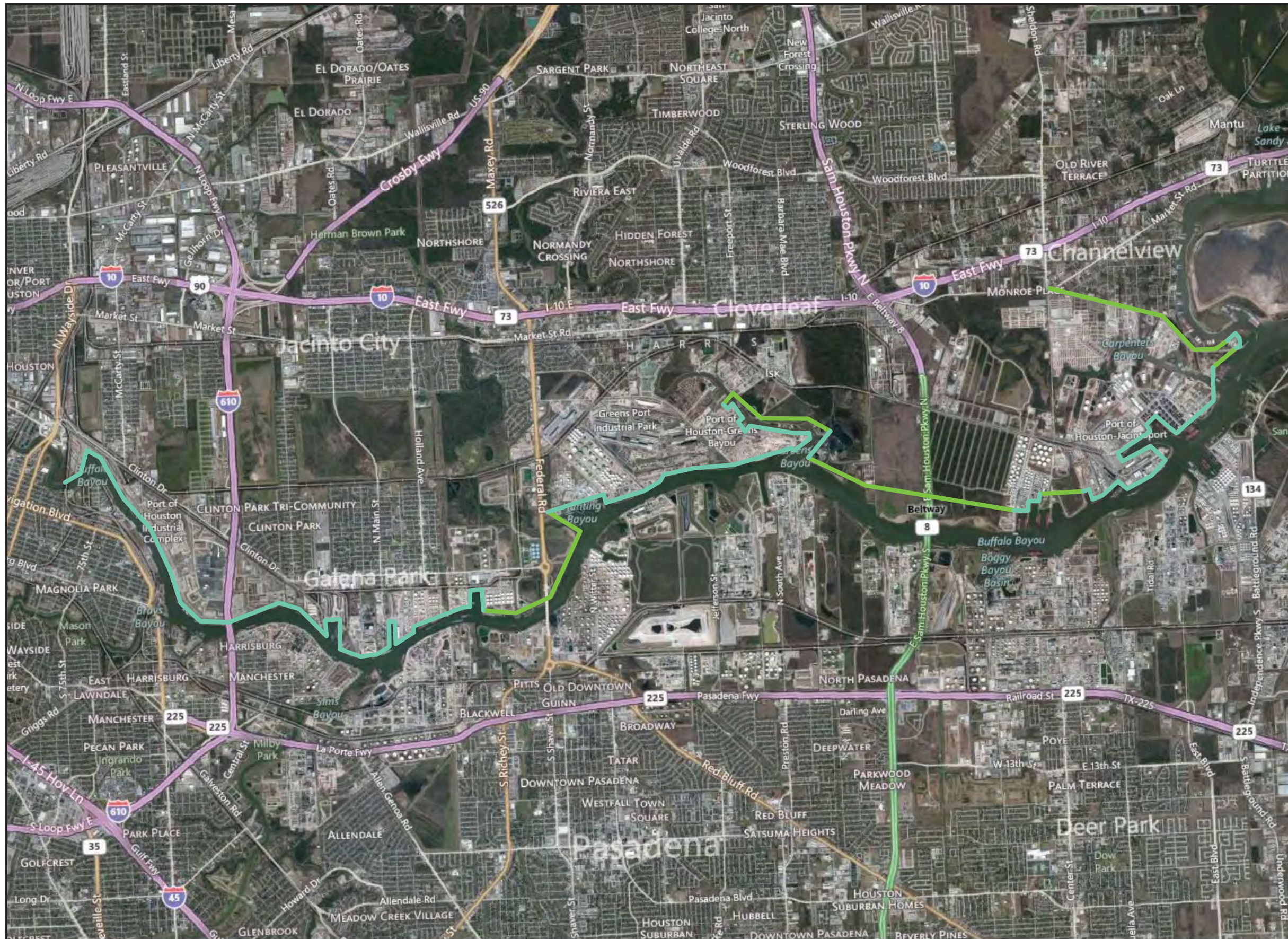

Legend

- Floodwall
- Levee

0 1,750 3,500 7,000 10,500 14,000

Feet

This product is reproduced from geospatial information prepared by the U.S. Army Corps of Engineers. GIS data and product accuracy may vary. Data may be developed from sources of differing accuracy, accurate only at certain scales, based on modeling or interpretation, incomplete while being created or revised, etc. Using GIS products for purposes other than those for which they were created may yield inaccurate or misleading results. The Corps of Engineers reserves the right to correct, update, modify, or replace GIS products without notifications.

Date Created: 4/24/2013

Measure 3-10.2: Local Surge Protection, Houston Ship Channel South, Harris County

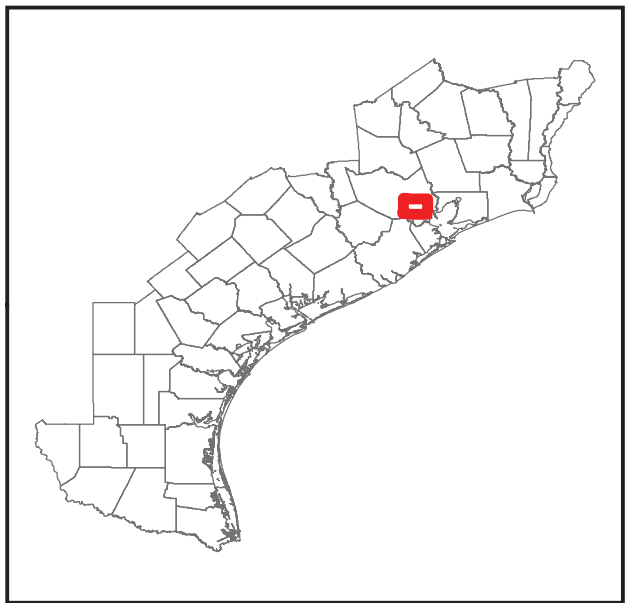
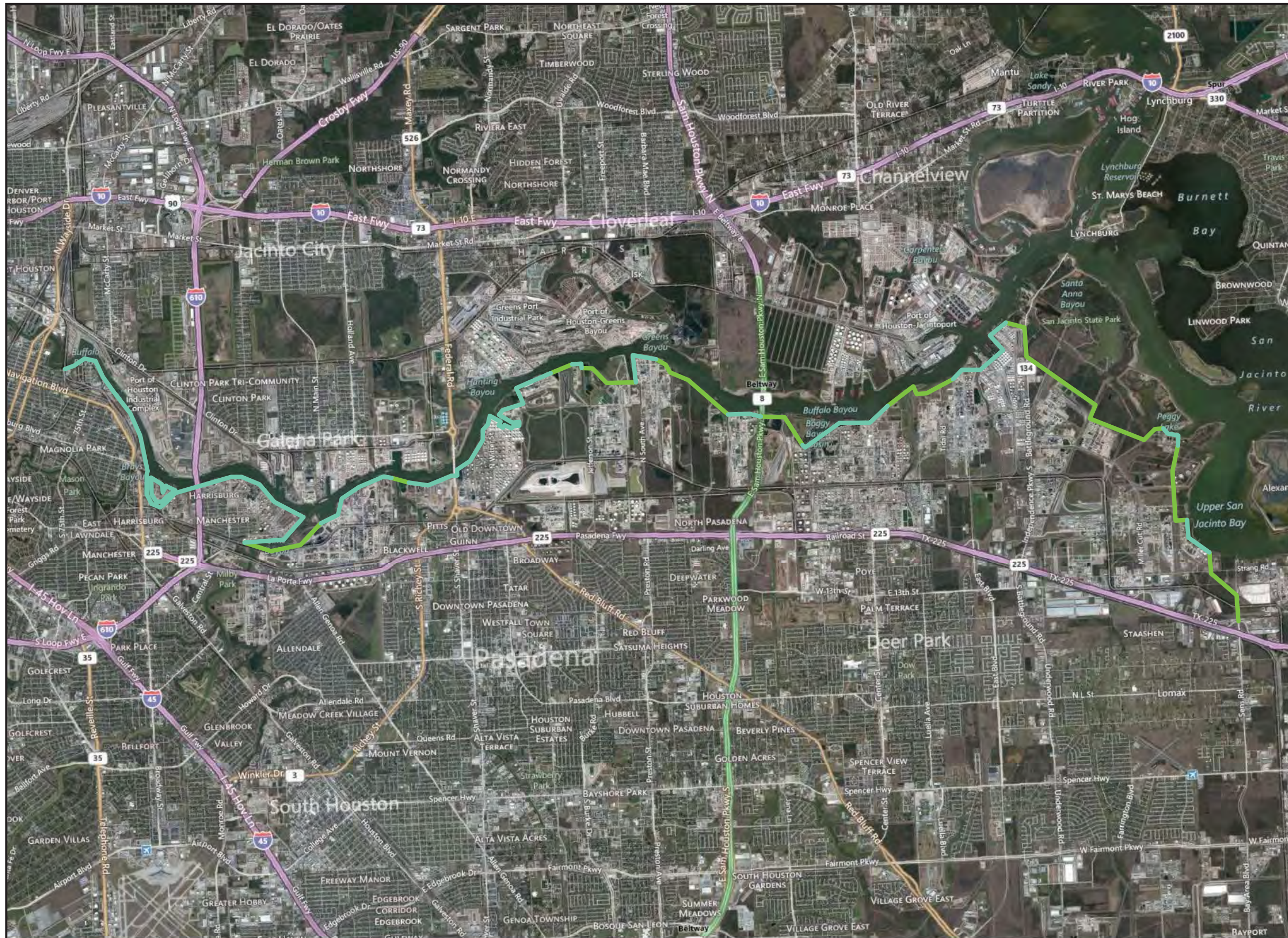

Legend

- Floodwall
- Levee

0 2,200 4,400 8,800 13,200 17,600 Feet

This product is reproduced from geospatial information prepared by the U.S. Army Corps of Engineers. GIS data and product accuracy may vary. Data may be developed from sources of differing accuracy, accurate only at certain scales, based on modeling or interpretation, incomplete while being created or revised, etc. Using GIS products for purposes other than those for which they were created may yield inaccurate or misleading results. The Corps of Engineers reserves the right to correct, update, modify, or replace GIS products without notifications.

Measure 3-10.3: Local Surge Protection, Baytown, Harris County

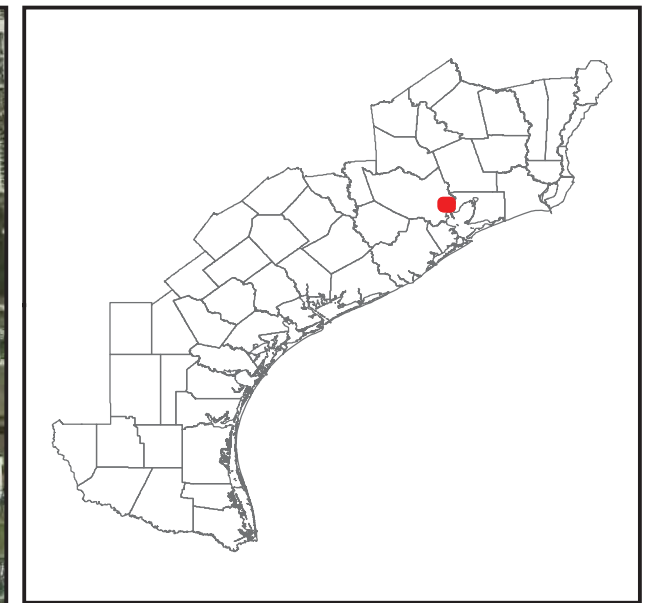
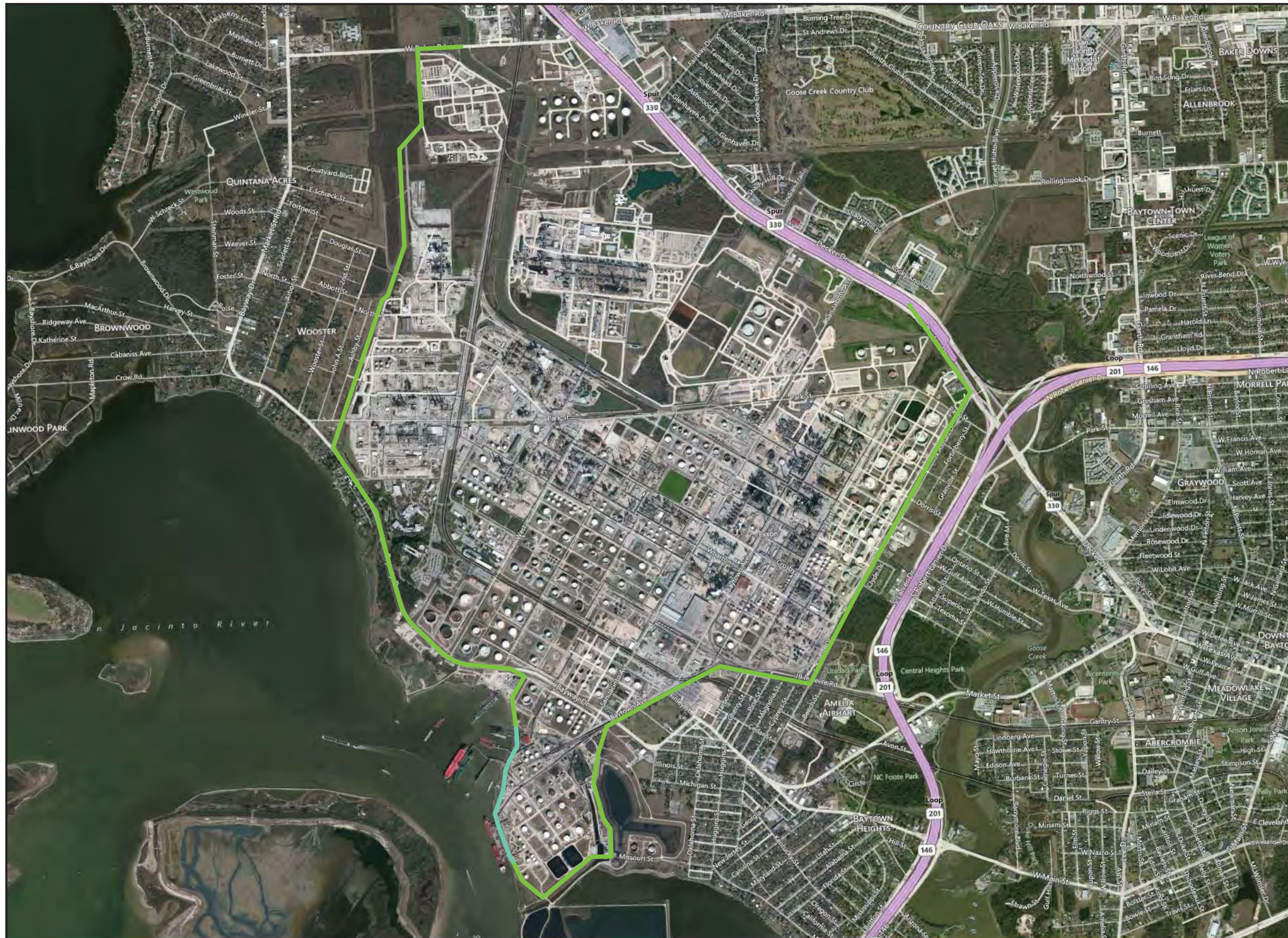

Legend

- Floodwall
- Levee

This product is reproduced from geospatial information prepared by the U.S. Army Corps of Engineers. GIS data and product accuracy may vary. Data may be developed from sources of differing accuracy, accurate only at certain scales, based on modeling or interpretation, incomplete while being created or revised, etc. Using GIS products for purposes other than those for which they were created may yield inaccurate or misleading results. The Corps of Engineers reserves the right to correct, update, modify, or replace GIS products without notifications.

Measure 3-10.4: Local Surge Protection, NASA, Harris County

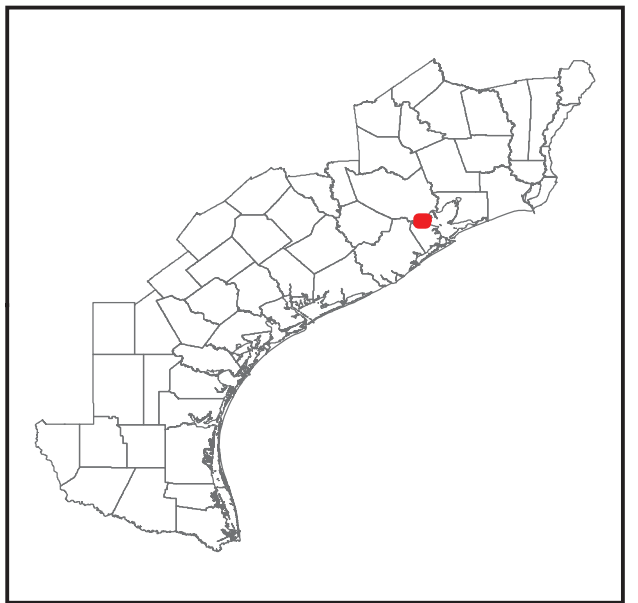

Legend

 Ring Levee



0 650 1,300 2,600 3,900 5,200 Feet



This product is reproduced from geospatial information prepared by the U.S. Army Corps of Engineers. GIS data and product accuracy may vary. Data may be developed from sources of differing accuracy, accurate only at certain scales, based on modeling or interpretation, incomplete while being created or revised, etc. Using GIS products for purposes other than those for which they were created may yield inaccurate or misleading results. The Corps of Engineers reserves the right to correct, update, modify, or replace GIS products without notifications.

Date Created: 4/24/2013



Measure 3-10.5: Local Surge Protection, UTMB, Galveston County

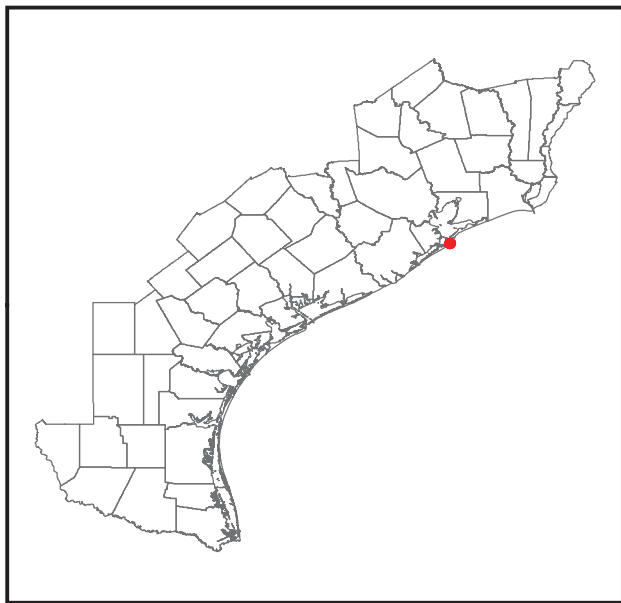

Legend

 Ring Levee



0 105 210 420 630 840 Feet



This product is reproduced from geospatial information prepared by the U.S. Army Corps of Engineers. GIS data and product accuracy may vary. Data may be developed from sources of differing accuracy, accurate only at certain scales, based on modeling or interpretation, incomplete while being created or revised, etc. Using GIS products for purposes other than those for which they were created may yield inaccurate or misleading results. The Corps of Engineers reserves the right to correct, update, modify, or replace GIS products without notifications.

Date Created: 4/24/2013



Typical Section S-04: Orange County Floodwall

* SECTION TAKEN FROM ORANGE COUNTY FLOOD PROTECTION STUDY

PROTECTED SIDE

FLOOD SIDE

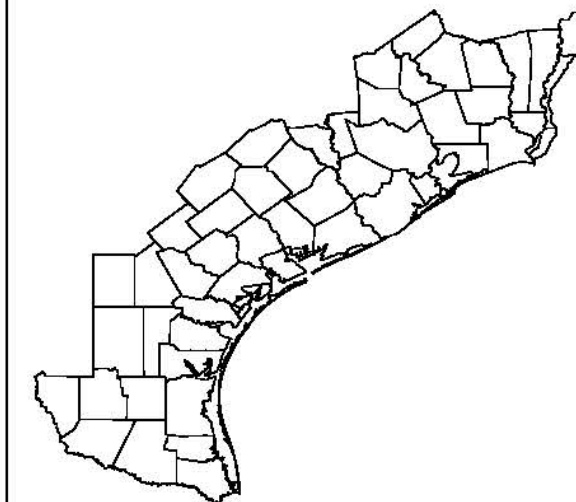
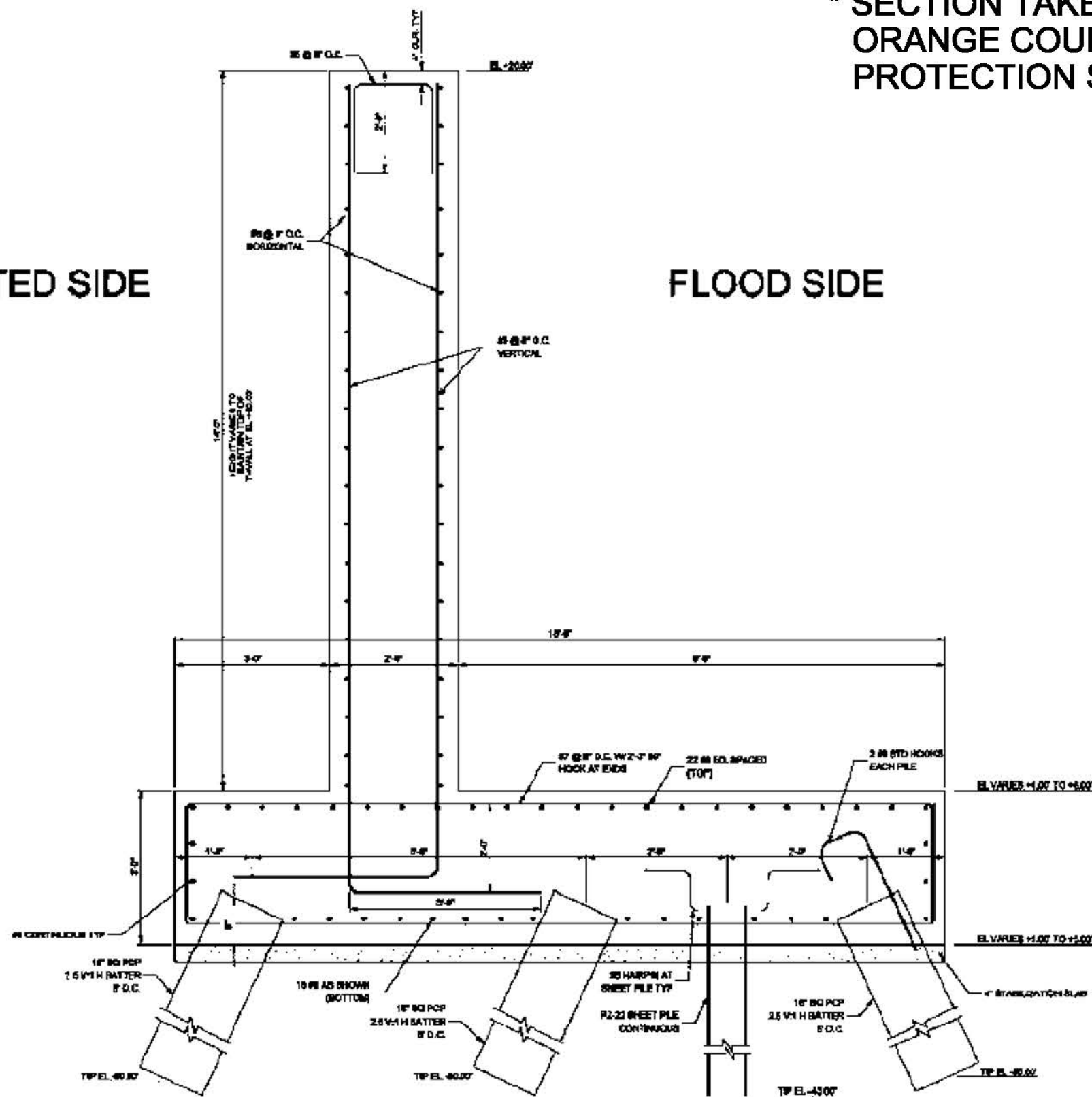

Typical Section S-04

Measures:

- 3-4
- 3-5
- 3-6
- 3-7
- 3-8
- 3-9
- 3-10



This product is reproduced from geospatial information prepared by the U.S. Army Corps of Engineers. GIS data and product accuracy may vary. Data may be developed from sources of differing accuracy, accurate only at certain scales, based on modeling or interpretation, incomplete while being created or revised, etc. Using GIS products for purposes other than those for which they were created may yield inaccurate or misleading results. The Corps of Engineers reserves the right to correct, update, modify, or replace GIS products without notifications.

Date Created: 4/24/2013



Typical Section S-05: Orange County Levee

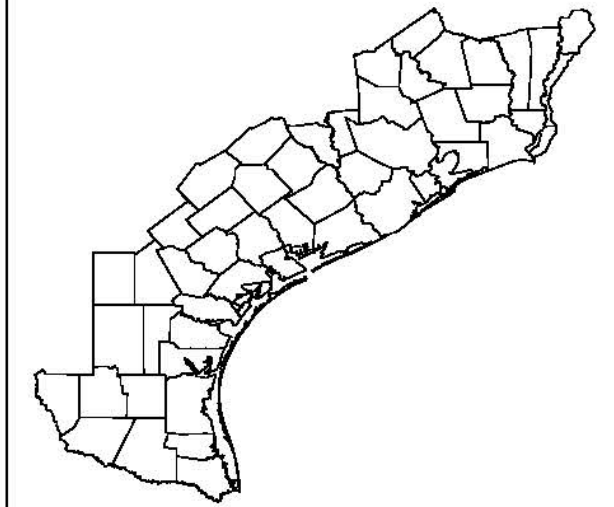
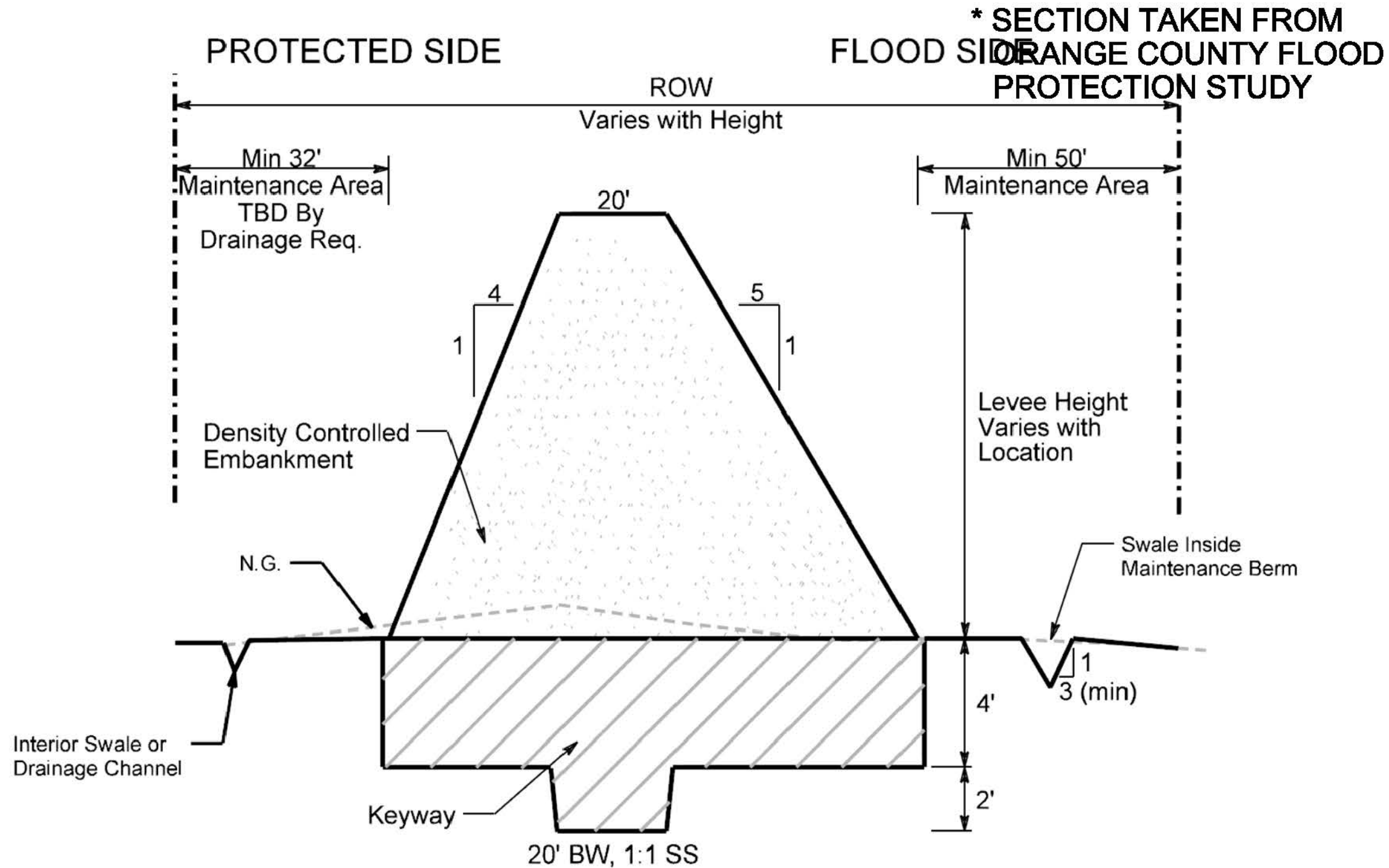

Typical Section S-05

Measures:

- 3-4
- 3-5
- 3-6
- 3-7
- 3-8
- 3-9
- 3-10



This product is reproduced from geospatial information prepared by the U.S. Army Corps of Engineers. GIS data and product accuracy may vary. Data may be developed from sources of differing accuracy, accurate only at certain scales, based on modelling or interpretation, incomplete while being created or revised, etc. Using GIS products for purposes other than those for which they were created may yield inaccurate or misleading results. The Corps of Engineers reserves the right to correct, update, modify, or replace GIS products without notifications.

Date Created: 4/24/2013



SABINE PASS TO GALVESTON BAY, TEXAS
MEASURES 4-1, 4-2.1, 4-2.2 and 4-2.3
INFORMATION SHEET

DESCRIPTION OF MEASURES

The measures described below all involve road raisings, but they are divided into two separate types of projects. Measure 4-1 involves the raising a highway along the west coast of Galveston Bay to a sufficient height that would protect human lives and infrastructure from impacts during a 100-year storm event. Measure 4-2 is comprised of 3 measures which raise highways on barrier islands and headlands to a lower elevation intended to protect environmentally sensitive areas from the effects of smaller but more frequent storms such as 10, 20 and 30-year events. It is assumed that the lower level of protection could provide significant ecosystem benefits while avoiding the large impacts and costs of a barrier designed to protect human lives and infrastructure.

Measure 4-1: Raise State Highway 146, Galveston and Harris Counties. Rebuild and raise approximately 17 miles of Highway 146 from the existing Texas City Hurricane Protection Project levee to the vicinity of the Hartman Bridge on the Houston Ship Channel. Tie-in to a closure structure on the Houston Ship Channel is assumed. At an elevation of NAVD 25 feet, the new barrier would provide surge protection from a modified Ike-type event to numerous residential communities along the west shore of Galveston Bay in Galveston and Harris counties, in addition to industrial facilities at La Porte, Barber's Cut and Bayport, and important National infrastructure at NASA.

Measure 4-2.1 Raise State Highway 87 from Sabine Pass to High Island, Jefferson and Chambers Counties. Rebuild and raise approximately 32.5 miles (171,806 linear feet) of former State Highway 87 from High Island to Sabine Pass to protect environmentally sensitive areas in the Texas Point and McFaddin National Wildlife Refuges (NWR) and Sea Rim State Park. Located in Jefferson and Chambers counties, the highway has been closed for many years and most of the roadbed has eroded into the Gulf. In addition, the NWR's are undergoing significant wetland loss.

Measure 4-2.2 Raise State Highway 87 from High Island to Port Bolivar, Galveston County. Rebuild and raise approximately 27 miles (143,900 linear feet) of State Highway 87 from High Island to Port Bolivar to protect emergent marshes along the GIWW and on the bay side of Bolivar Peninsula in Galveston County. The highway was repaired after Hurricane Ike and serves as an important hurricane evacuation route..

Measure 4-2.3 Raise County Road 257, Brazoria County. Rebuild and raise approximately 14 miles (72,000 linear feet) of County Road 257 (also known as the Blue Water Highway) from San Luis Pass to Surfside to protect emergent marshes on the bay side of Follets Island in Brazoria County. The highway serves as an important hurricane evacuation route.

LOCATION OF MEASURES (See attached drawings)

Measure 4-1:

Typical Section S-06: Elevate SH-146

Raise State Highway 146, Galveston and Harris Counties

Measures 4-1, 4-2, 4-3:

Typical Section S-07: Elevate and Armor Coastal HWY-87 & CR-257

Measure 4-2.1: Raise State Highway 87 from Sabine Pass to High Island, Jefferson and Chambers Counties

Measure 4-2.2: Raise State Highway 87 from High Island to Port Bolivar, Galveston County

Measure 4-2.3: Raise County Road 257, Brazoria County

DESIGN ASSUMPTIONS

Measure 4-1:

- Existing ground elevation along stretch of SH 146 from Texas City HFP to Bayport is 12 ft MSL. From Bayport to the Hartman Bridge the roadway is at the proposed elevation of NAVD 88 25 ft.
- Roadway will consist of five 12' wide lanes, and two 10' wide shoulders.
- Roadway will be raised a total of 13 ft consisting of 11.5 ft of fill, 1.0 ft of road base, and 0.5 ft of paving. Side slopes will be at 1:3 ft.
- Utility and bridge relocation is not accounted for.
- Additional roadway right-of-way is not accounted for.

Measures 4-2.1, 4-2.2, and 4-2.3:

- All three Ecosystem Protection Design measures are at NAVD 88 levels lower than measure 4-1. Used GLO Brazoria CR 257 design.
- Roadway will be raised a total of 6' consisting of 4.5 ft of fill, 1.0 ft of road base, and

0.5 ft of paving. Side slopes will be at 1:3 ft. See plan sheet cross section S2 for details.

- Roadway has two 12 ft wide lanes and two shoulders at 8 ft wide each.
- The 3:1 side slopes would be armored with riprap. See plan sheet cross section S2 for details.
- Utility and bridge relocation is not accounted for.
- Additional roadway right-of-way is not accounted for.

HYDRAULICS & HYDROLOGY

The design storm used for the H&H analysis is the 100 year storm surge derived by FEMA using the recent results from the FEMA 2011 Texas coastal study. The ADCIRC results were converted into a without-project 100 year flood depth grid that corresponds to existing without-project conditions.

Raising State Highway 146, Measure 4-1 would have the most impact on the without-project condition of these measures. Everyone to the eastern side of the raised highway, along the west bay shoreline, would be inundated more than they previously have been and buyouts would have to be considered. Additionally, the drainage behind a raised Highway 146 would be of concern and design would need to be modeled extensively.

Measures 4-2.1, 4-2.2 and 4-3 would have some impact with regard to surge protection, but primarily for events lesser than the 100-year storm surge. In order to fully understand the effects of these measures, smaller storms should be examined and cross shore transport modeling with SBEACH (Storm Induced Beach Change Model) and possibly some longshore sediment transport with GENESIS (Generalized Model for Causing Shoreline Change) should be conducted.

REAL ESTATE

A detailed breakdown of Real Estate costs can be found in the supplemental document 'Sabine Pass to Galveston Bay, Texas Preliminary Real Estate Cost Estimate'.

- Measure 4-1: Raise State Highway 146, Galveston and Harris Counties
Total Estimated Real Estate Cost: \$73,200,000 ®
- Measure 4-2.1 Raise State Highway 87 from Sabine Pass to High Island, Jefferson and Chambers Counties
Total Estimated Real Estate Cost: \$39,400,000 ®

- Measure 4-2.2 Raise State Highway 87 from High Island to Port Bolivar, Galveston County
 Total Estimated Real Estate Cost of Measure 4-2.2: \$42,400,000 ®
- Measure 4-2.3 Raise County Road 257, Brazoria County
 Total Estimated Cost: \$15,700,000 ®

ENVIRONMENTAL

Measure 4-1 would reduce surge damages due to scouring and marsh loss caused by elevated salinities following the storm. The protected area would be equivalent to the area H&H modeling determined would be protected by construction of the measure.

Measures 4-2.1, 4-2.2 and 4-2.3 would have little beneficial environmental effects for a 100-year storm, but they could have a significant effect as a first line of defense for storms of lower magnitude such as 10-, 20, 30-year events. The higher roadbeds would be effective at blocking the storm surge of smaller storms, thus prevent scouring and salinity insults to fresher wetland environments over a large area inland from the roadway. No H&H modeling was conducted to determine areas that would be protected by measures for the smaller but more frequent storm events. The wetland acre benefits presented below assume that the benefits would extend inland up to the vicinity of the Gulf Intracoastal Waterway.

Environmental benefits are presented in wetland acres that would be protected by this measure. The wetland acres were calculated with a GIS analysis of National Wetland Inventory wetland maps (USFWS, 2012).

BENEFITS

With and without project damages to structures, contents, and vehicles were calculated using HEC-FIA (Flood Impact Analysis) software package which analyzes consequences for a given flood event, in this case, a 1% annual exceedance probability (100-year). Without project damages are those that would occur under the current existing condition. Residual damages are those that would occur with a given measure in place. Benefits are the difference between the two. These numbers are listed in the tables below.

This economic analysis does not take into account losses of human life or impacts to the economy of the region that would result from economic and industrial disruptions caused by storm surge. It could take weeks to get critical petro-chemical facilities back on-line, and

months to clean-up and fully repair flooded facilities. The lives of thousands of people would be disrupted until homes could be rebuilt, and temporary dislocations would adversely effect employers who would loose employees as they relocate to other areas.

Storm Surge Regions

Region	Counties
6	Brazoria, Galveston, Harris
7	Chambers, Galveston, Harris, Jefferson
8	Chambers, Jefferson, Orange

Benefits for Measures 4-1 to 4-2.3

Measure 4-1: Raise State Highway 146, Galveston and Harris Counties			Region 6
	Without Project Damages	Residual Damages	Benefits
Structure	\$5,630,895,000	\$4,115,223,000	\$1,515,672,000
Contents	\$5,854,589,000	\$4,585,865,000	\$1,268,724,000
Vehicles	\$1,337,005,000	\$1,048,105,000	\$288,900,000
Total	\$12,822,489,000	\$9,749,193,000	\$3,073,296,000

Measure 4-2.1: Raise State Highway 87 from Sabine Pass to High Island, Jefferson and Chambers Counties			Region 8
	Without Project Damages	Residual Damages	Benefits
Structure	\$1,041,712,000	\$1,006,288,000	\$35,424,000
Contents	\$1,078,037,000	\$1,042,874,000	\$35,163,000
Vehicles	\$362,768,000	\$349,603,000	\$13,165,000
Total	\$2,482,517,000	\$2,398,765,000	\$83,752,000

Measure 4-2.2: Raise State Highway 87 from High Island to Port Bolivar, Galveston County			Region 7
	Without Project Damages	Residual Damages	Benefits
Structure	\$1,016,448,000	\$1,008,479,000	\$7,969,000
Contents	\$833,516,000	\$826,053,000	\$7,463,000
Vehicles	\$252,516,000	\$252,516,000	\$0
Total	\$2,102,480,000	\$2,087,048,000	\$15,432,000

Measure 4-2.3: Raise County Road 257, Brazoria County			Region 6
	Without Project Damages	Residual Damages	Benefits
Structure	\$5,630,895,000	\$5,609,442,000	\$21,453,000
Contents	\$5,854,589,000	\$5,840,373,000	\$14,216,000

Vehicles	\$1,337,005,000	\$1,336,965,000	\$40,000
Total	\$12,822,489,000	\$12,786,780,000	\$35,709,000

COSTS

These costs do not include Real Estate costs.

Measure 4-1: Raise State Highway 146, Galveston and Harris Counties

The estimated cost for this measure is \$489,890,000.

The basis for the cost of the flood control structures required at Dickinson Bayou, Channel to Clear Lake, and Taylor Bayou were derived from the TAMU Ike Dike report.

The basis for the unit prices used was derived from the General Land Office work on Brazoria Co. Road 257 and the Ike Dike report.

Measure 4-2.1: Raise State Highway 87 from Sabine Pass to High Island, Jefferson and Chambers Counties.

The estimated cost for this measure is \$387,654,000.

The basis for the unit prices used was derived from the General Land Office work on Brazoria Co. Road 257.

Measure 4-2.2: Raise State Highway 87 from High Island to Port Bolivar, Galveston County.

The estimated cost for this measure is \$324,547,000.

The basis for the unit prices used was derived from the General Land Office work on Brazoria Co. Road 257.

Measure 4-2.3: Raise County Road 257, Brazoria County.

The estimated cost for this measure is \$162,274,000.

The basis for the unit prices used was derived from the General Land Office work on Brazoria Co. Road 257.

Additional Cost Assumption:

- A standard 25% contingency, E&D of 8%, and CM of 6% were added to the cost.

REFERENCE DOCUMENTS

Hwy 146 alignment and raising - SSPEED Center Phase I Report: Learning the Lessons of Hurricane Ike: Preparing for the Next Big One, November 2011.

For Hwy 87 and CR 257 – Brazoria County Plans of Proposed County Road Repair and Protection CR 257 (Blue Water Highway).

Applying best practices from the Delta Works and New Orleans to Galveston Bay, Prepared by: Kasper Stoeten, Master Student Hydraulic Engineering, Delft University of Technology, November 2012.

U.S. Fish and Wildlife Service. 2012. National Wetland Inventory. Accessed on the internet at <http://www.fws.gov/wetlands/Data/Mapper.html>

RISKS

- The alignment for measure 4-1 was taken from the SSPEED center proposals.
- Geotechnical and structural feasibility of the proposal was not reviewed by the COE.
- No review of available public information or data from in-house files relative to the general geology and soil conditions for the proposed features was conducted.
- System configuration and the proposed structures were not assessed by the COE.
- The area of environmental benefits for measures 4-2.1, 4-2.2, and 4-3 was estimated based on best professional judgment. H&H modeling would be needed to determine the actual area of protection.

Sabine Pass to Galveston Bay Texas, Coastal Storm Risk Management and Ecosystem Restoration Feasibility Study

Measure 4: Raise State Highways 146 And 87, And County Road 257

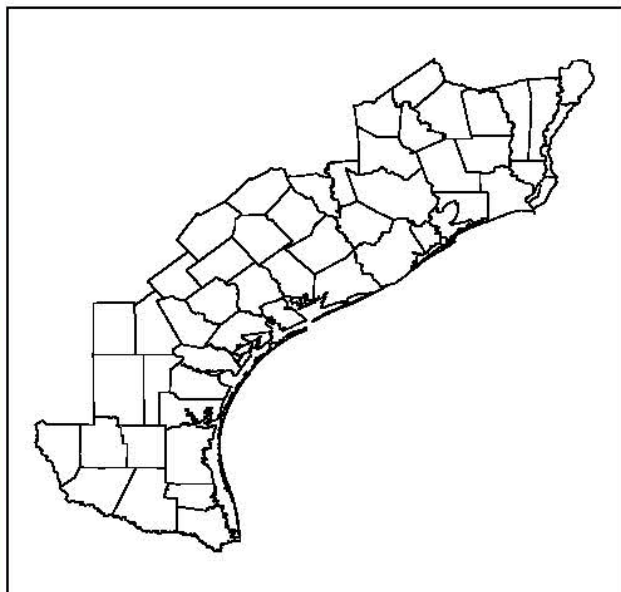
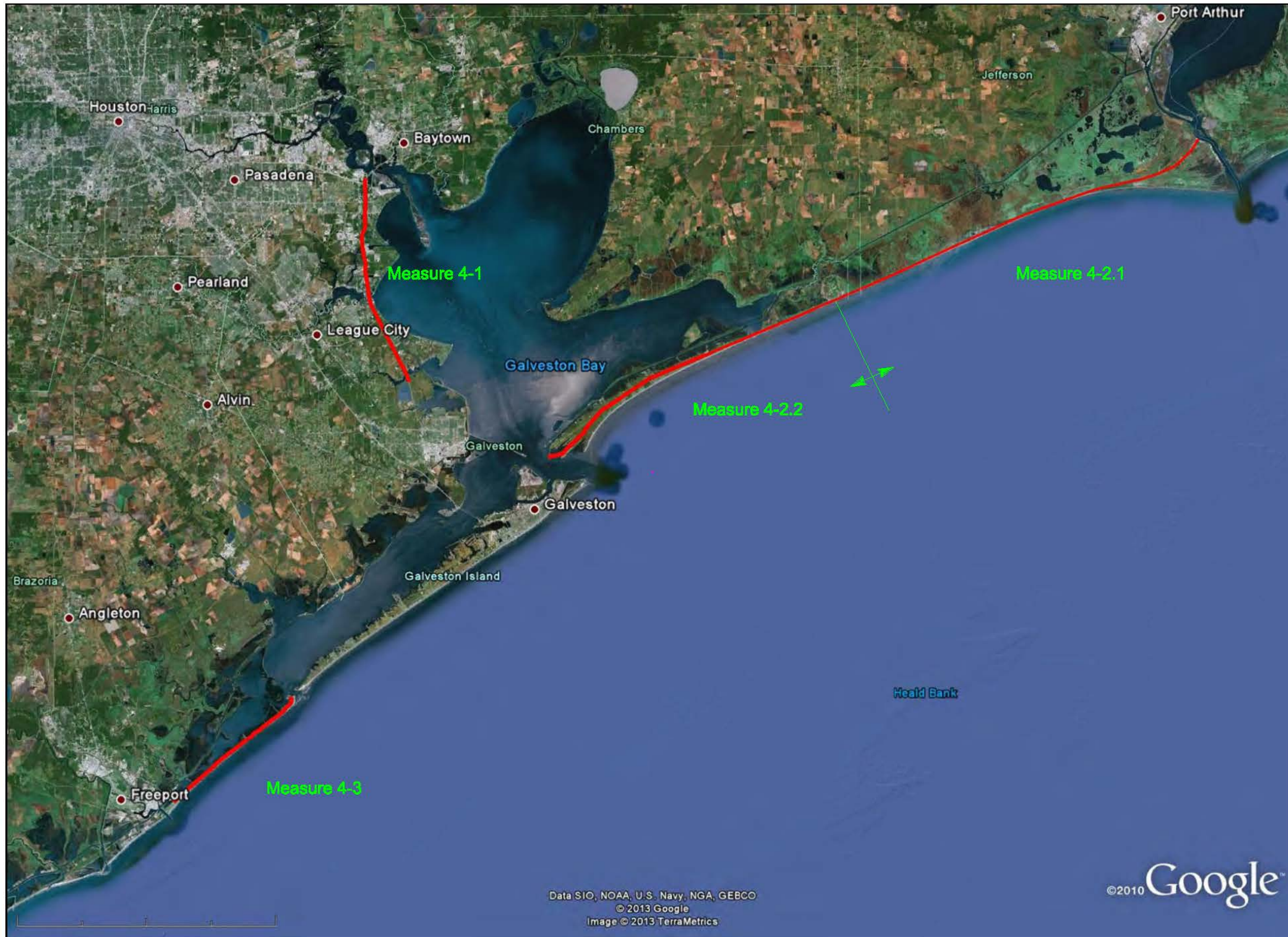

Legend

— Measure 4

This product is reproduced from geospatial information prepared by the U.S. Army Corps of Engineers. GIS data and product accuracy may vary. Data may be developed from sources of differing accuracy, accurate only at certain scales, based on modeling or interpretation, incomplete while being created or revised, etc. Using GIS products for purposes other than those for which they were created may yield inaccurate or misleading results. The Corps of Engineers reserves the right to correct, update, modify, or replace GIS products without notifications.

Date Created: 4/11/2013

Measure 4-1: Raise State Highway 146

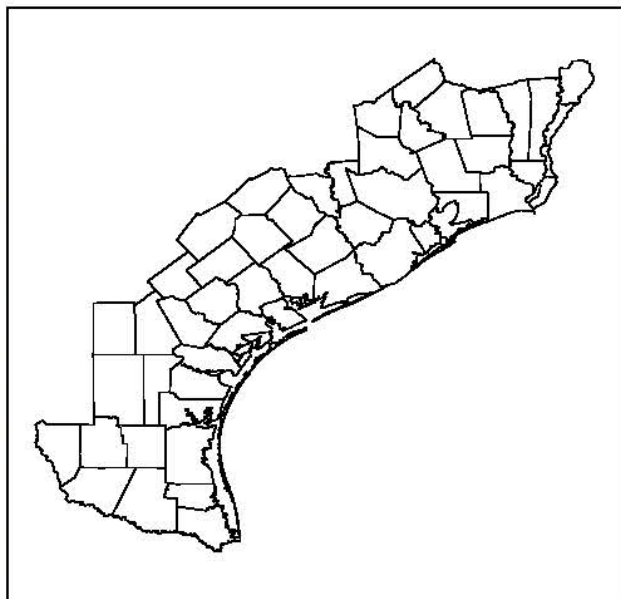
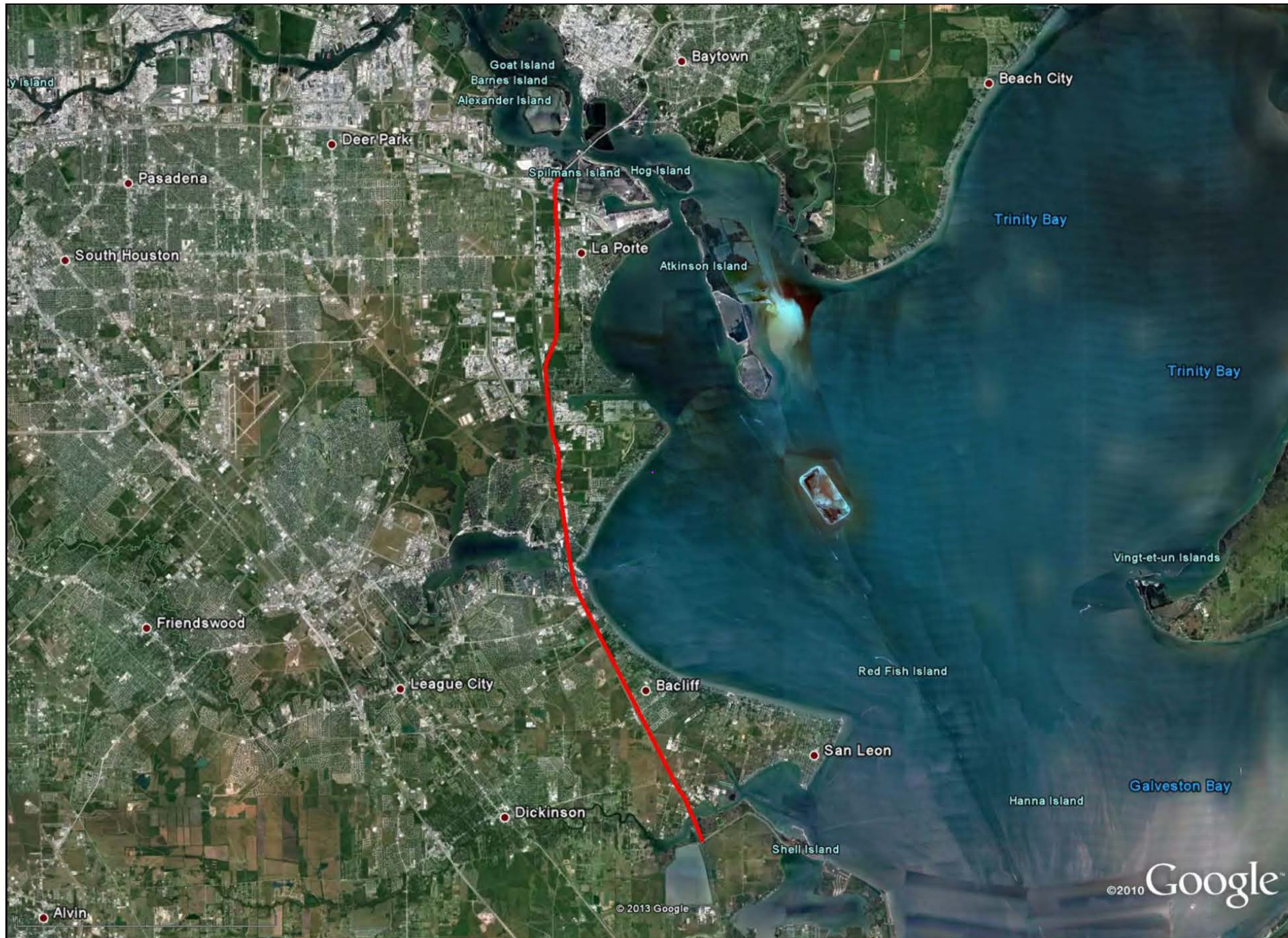

Legend

— Measure 4-1



This product is reproduced from geospatial information prepared by the U.S. Army Corps of Engineers. GIS data and product accuracy may vary. Data may be developed from sources of differing accuracy, accurate only at certain scales, based on modeling or interpretation, incomplete while being created or revised, etc. Using GIS products for purposes other than those for which they were created may yield inaccurate or misleading results. The Corps of Engineers reserves the right to correct, update, modify, or replace GIS products without notifications.

Date Created: 4/11/2013



Measure 4-2.1: Raise State Highway 87 From Sabine Pass To High Island

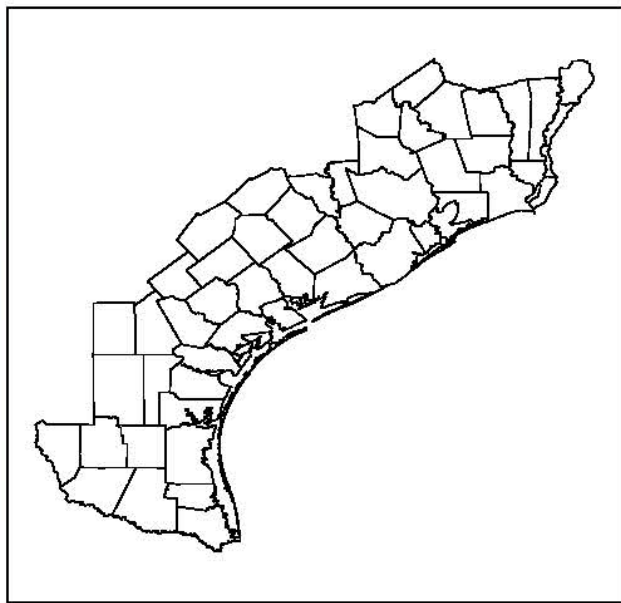
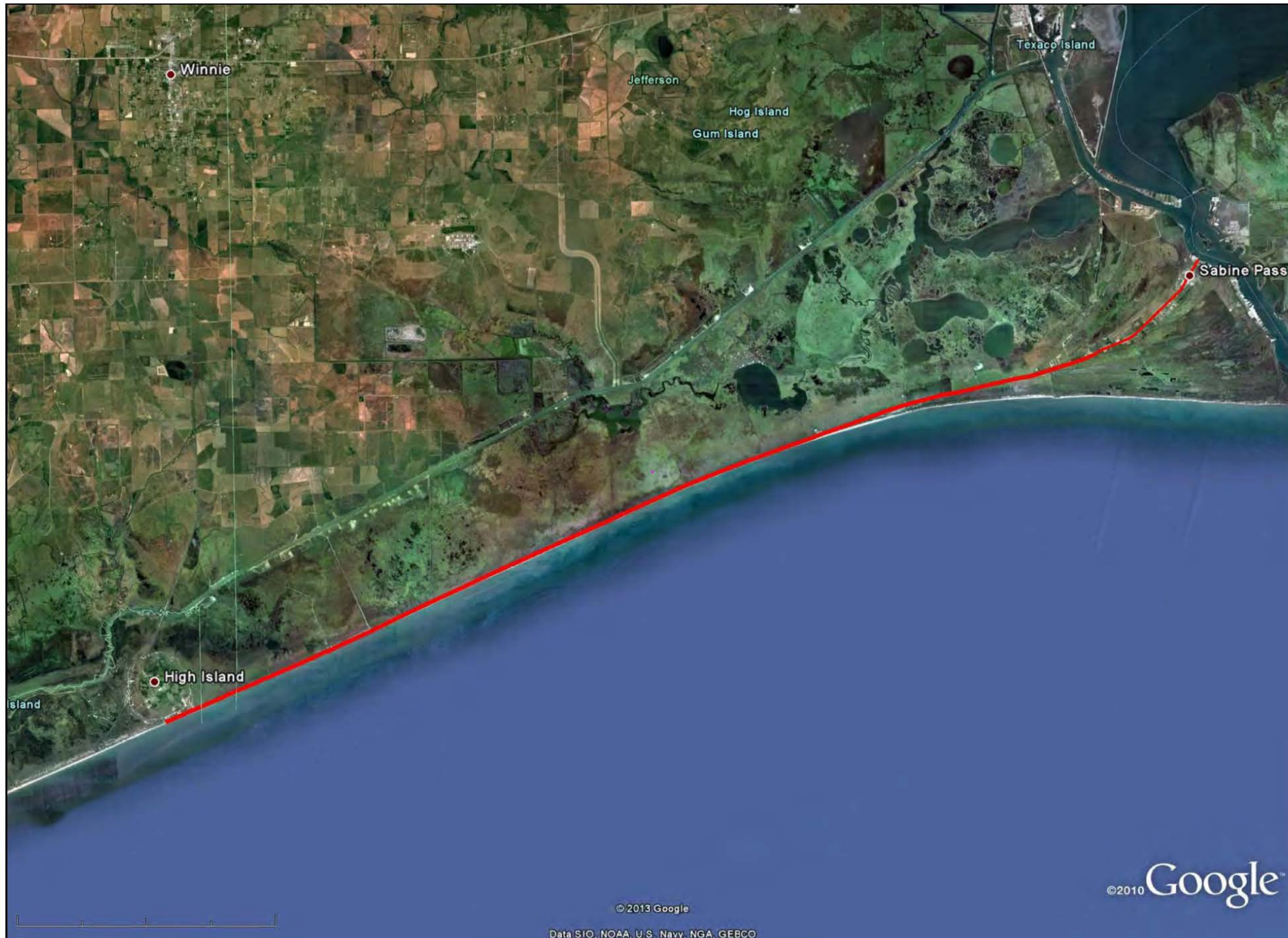

Legend

— Measure 4-2.1



This product is reproduced from geospatial information prepared by the U.S. Army Corps of Engineers. GIS data and product accuracy may vary. Data may be developed from sources of differing accuracy, accurate only at certain scales, based on modeling or interpretation, incomplete while being created or revised, etc. Using GIS products for purposes other than those for which they were created may yield inaccurate or misleading results. The Corps of Engineers reserves the right to correct, update, modify, or replace GIS products without notifications.



Date Created: 4/11/2013

Measure 4-2.2: Raise State Highway 87 From High Island To Port Bolivar

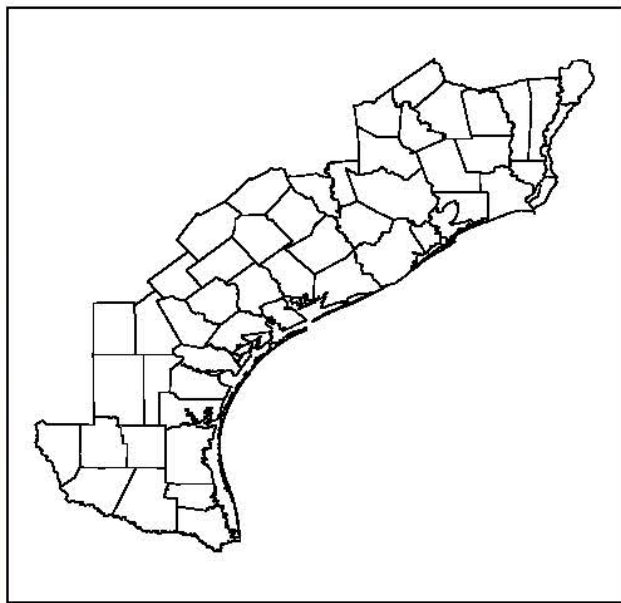
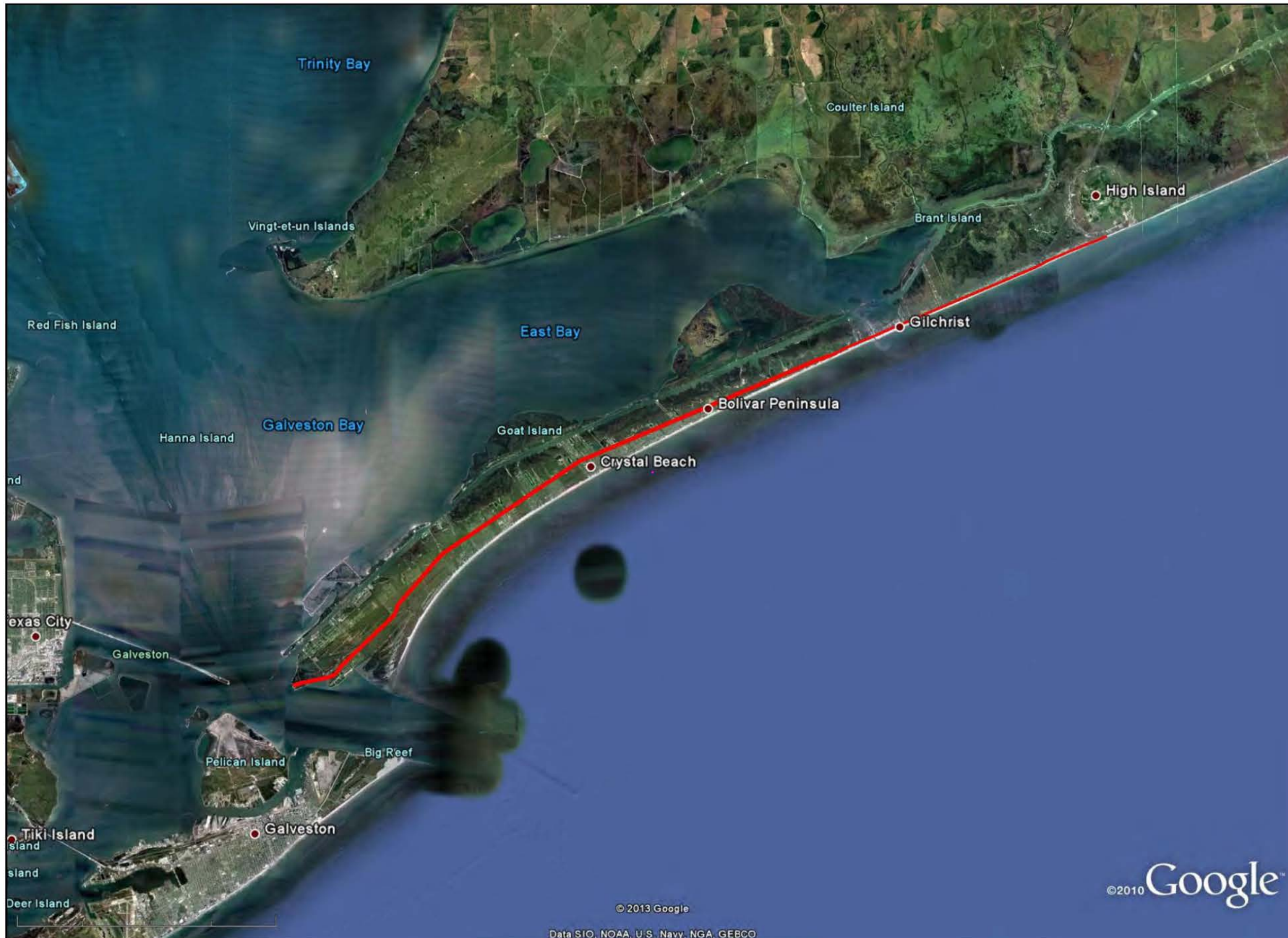

Legend

— Measure 4-2.2



This product is reproduced from geospatial information prepared by the U.S. Army Corps of Engineers. GIS data and product accuracy may vary. Data may be developed from sources of differing accuracy, accurate only at certain scales, based on modeling or interpretation, incomplete while being created or revised, etc. Using GIS products for purposes other than those for which they were created may yield inaccurate or misleading results. The Corps of Engineers reserves the right to correct, update, modify, or replace GIS products without notifications.



Date Created: 4/11/2013

Measure 4-3: Raise County Road 257

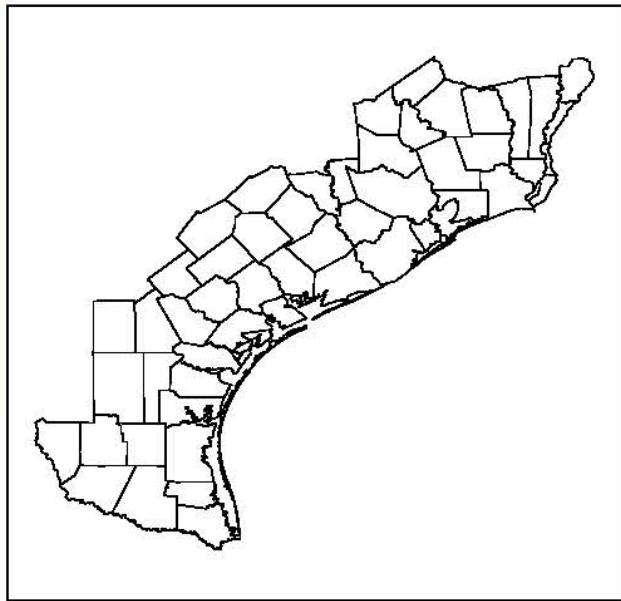
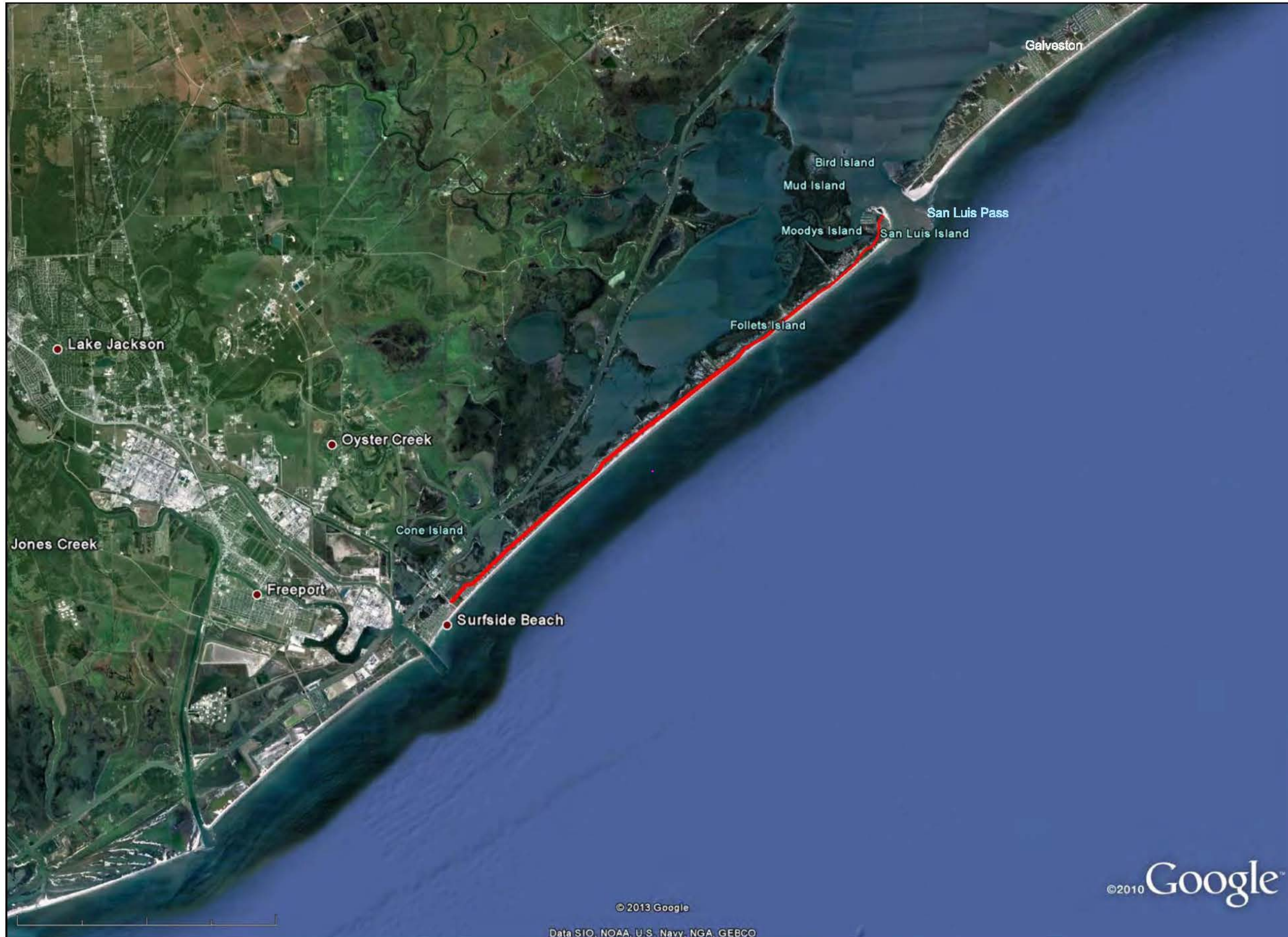

Legend

— Measure 4-3



This product is reproduced from geospatial information prepared by the U.S. Army Corps of Engineers. GIS data and product accuracy may vary. Data may be developed from sources of differing accuracy, accurate only at certain scales, based on modeling or interpretation, incomplete while being created or revised, etc. Using GIS products for purposes other than those for which they were created may yield inaccurate or misleading results. The Corps of Engineers reserves the right to correct, update, modify, or replace GIS products without notifications.



Date Created: 4/11/2013

Typical Section S-06: Elevate SH-146

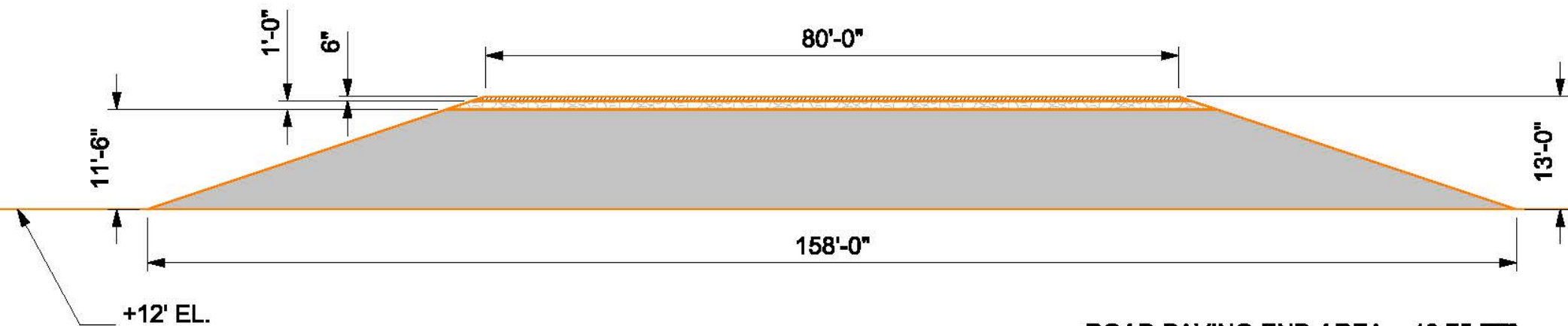
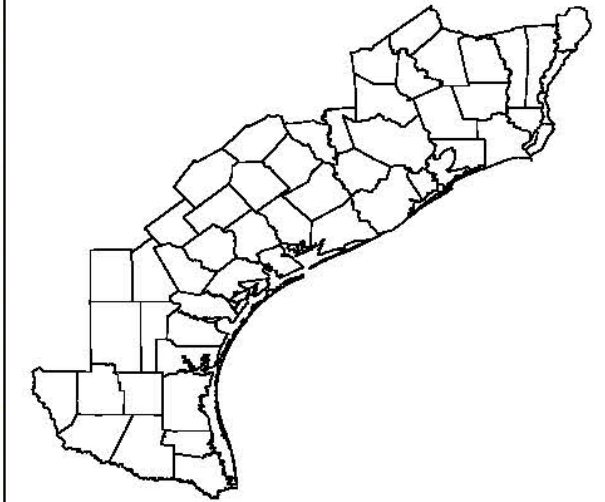

ROAD PAVING END AREA = 40.75 FT²
 ROAD BASE END AREA = 86.0 FT²
 ROAD FILL END AREA = 1420.25 FT²

Typical Section S-06

Measure:
4-1

S-10

ASSUMPTIONS:

1. FILL IS COMPACTED 95% STANDARD
2. FILL IS TRUCKED IN HAUL DISTANCE IS 5 MILES
3. VOLUME IS BASED ON CROSS SECTION AREA MULTIPLIED BY LENGTH
4. ROAD PAVING IS ASPHALT



This product is reproduced from geospatial information prepared by the U.S. Army Corps of Engineers. GIS data and product accuracy may vary. Data may be developed from sources of differing accuracy, accurate only at certain scales, based on modeling or interpretation, incomplete while being created or revised, etc. Using GIS products for purposes other than those for which they were created may yield inaccurate or misleading results. The Corps of Engineers reserves the right to correct, update, modify, or replace GIS products without notifications.

Date Created: 4/15/2013



Typical Section S-07: Elevate And Armor Coastal HWY-87 & CR-257

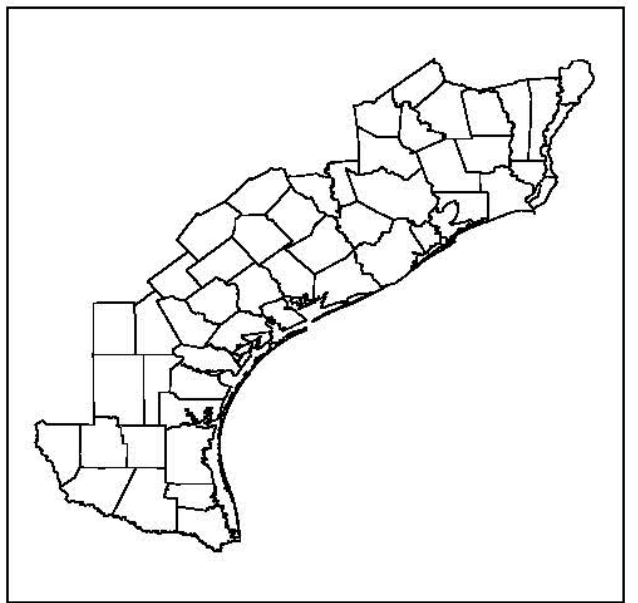
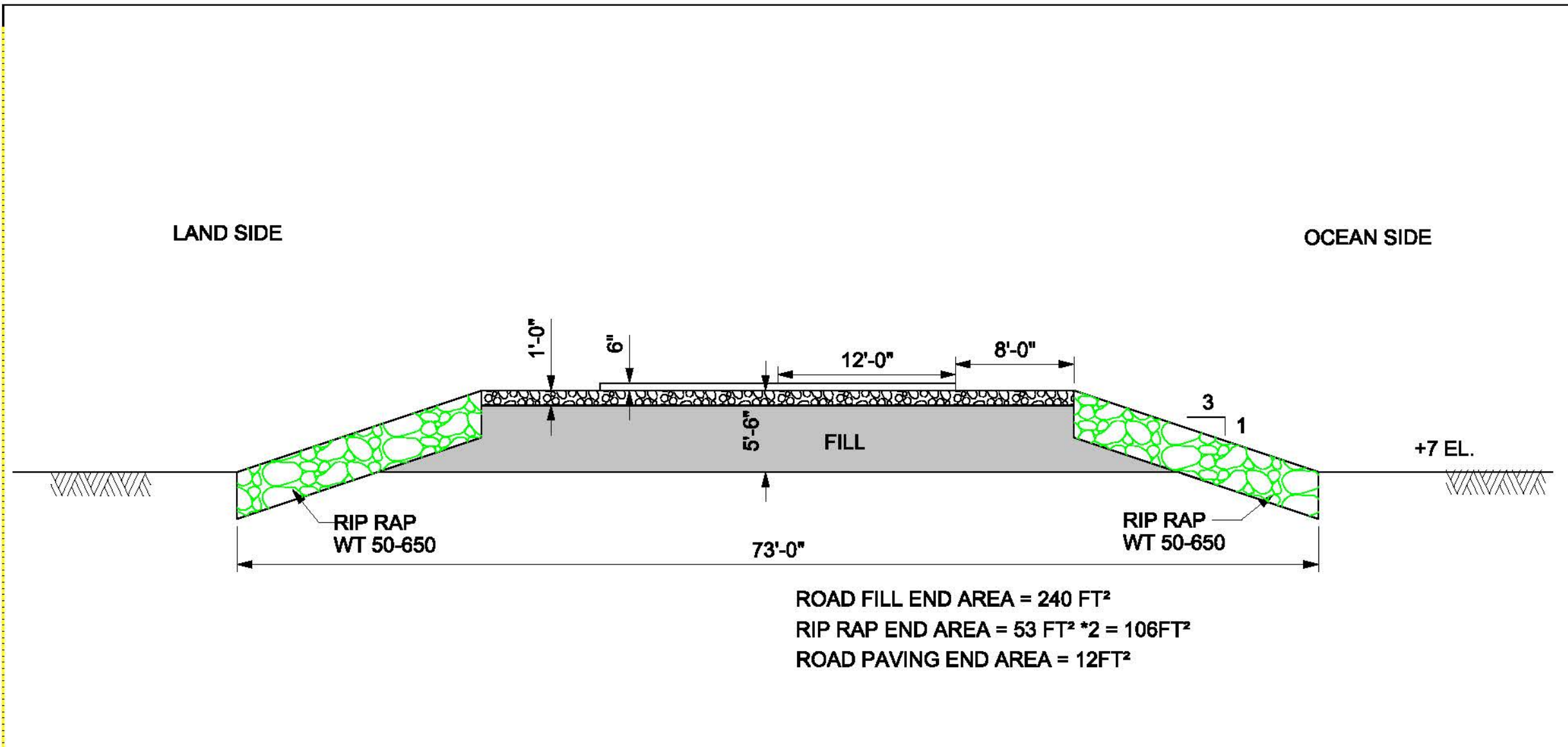

Typical Section S-07

- Measures:
 4-2.1
 4-2.2
 4-3

- ASSUMPTIONS:**
- 1: FILL IS COMPACTED 95% STANDARD
 - 2: FILL IS TRUCKED IN HAUL DISTANCE IS 5 MILES
 - 3: ROAD TEMPLATE IS FOUNDED ON THE 7 FT CONTOUR
 - 4: RIP RAP IS A UNIFORM 2FT THICKNESS
 - 5: VOLUME IS BASED ON CROSS SECTION AREA MULTIPLIED BY LENGTH
 - 6: ROAD PAVING IS ASPHALT
 - 7: STRIPING IS 6IN



This product is reproduced from geospatial information prepared by the U.S. Army Corps of Engineers. GIS data and product accuracy may vary. Data may be developed from sources of differing accuracy, accurate only at certain scales, based on modeling or interpretation, incomplete while being created or revised, etc. Using GIS products for purposes other than those for which they were created may yield inaccurate or misleading results. The Corps of Engineers reserves the right to correct, update, modify, or replace GIS products without notifications.

Date Created: 4/15/2013



SABINE PASS TO GALVESTON BAY, TEXAS
MEASURE 5-1
INFORMATION SHEET

DESCRIPTION OF MEASURE 5-1 Chenier Ridge Restoration, Jefferson County

This measure would restore three Chenier ridges in the Texas Point National Wildlife Refuge that once protected the marsh from storm surge impacts. Chenier Ridge 1 would be 13,000 ft long by 600 ft wide by 10-15 ft high. Chenier Ridge 2 would be 9,500 ft long by 600 feet wide by 10-15 ft high. Chenier Ridge 3 would be 25,500 ft long by 2,100 ft wide and 15 ft hi

DESIGN ASSUMPTIONS

- The reconstruction of the three ridges would require approximately 27,530,000 CY of fill.
- The ridges would be constructed by hydraulic fill from an offshore source at Sabine Bank using a hopper dredge with a maximum 3 mile pump out distance.
- The topsoil would be trucked in using a 12 mile haul distance.
- The topsoil area would be hydro-mulched with coastal Bermuda grass over entire area of ridge.
- Dozer would be used to spread the material.
- Assume placement of 1 foot of top soil worked into to flat tops of ridges and side slopes to promote growth of vegetation.
- Assume planting tree seedlings of oak and hackberries at 30 feet on center.

HYDRAULICS & HYDROLOGY

No H&H analysis was performed for this phase of the study. The location and size of the reconstructed ridges were based on historical maps, and their function as surge attenuators was assumed based on a report prepared by Louisiana's Department of Natural Resources (DNR, 2009) and other historical accounts.

REAL ESTATE

A detailed breakdown of Real Estate costs can be found in the supplemental document 'Sabine Pass to Galveston Bay, Texas Preliminary Real Estate Cost Estimate'. Costs identified as \$0 are generally associated with Federal and/or State lands.

- Measure 5-1: Chenier Ridge Restoration, Jefferson County
Total Estimated Real Estate Cost Measure 5-1 \$0

ENVIRONMENTAL

The environmental benefits for this measure, as presented here, are limited to approximately 1,200 total acres of Chenier ridge restoration. An H&H study would need to be performed to evaluate the efficacy of Chenier ridges in storm surge protection in this area. Given the height and limited footprint of these ridges, any surge protection would be limited to smaller but more frequent storms such as 10, 20 and 30-year events. The ridge acres were calculated with a GIS analysis of National Wetland Inventory wetland maps (USFWS, 2012).

BENEFITS

All benefits are assumed be environmental for this phase of analysis.

COSTS

This cost does not include Real Estate cost.

The estimated cost for this measure is \$ \$328,136,102.

REFERENCE DOCUMENTS

Louisiana Department of Natural Resources (DNR). 2009. Cheniers and Natural Ridges Study. Prepared for Louisiana DNR by Providence Engineering and Environmental Group, LLC, Baton Rouge.

U.S. Fish and Wildlife Service. 2012. National Wetland Inventory. Accessed on the internet at <http://www.fws.gov/wetlands/Data/Mapper.html>

RISKS

- The alignment was estimated.
- Geotechnical and structural feasibility of the proposal was not reviewed.
- Ground elevations were estimated.
- No review of available public information or data from in-house files relative to the general geology and soil conditions for the proposed features was conducted.

- Engineering analyses need to be conducted to determine strongest possible engineered structure.
- Fill material and source would need to be verified.
- H&H modeling of storm surge attenuation effects would need to be conducted.
- Extent of Chenier ridges is limited to historical footprint, which may limit the ridges surge attenuation effectiveness in this area.

Measure 5-1: Chenier Beach Ridge Restoration, Jefferson County

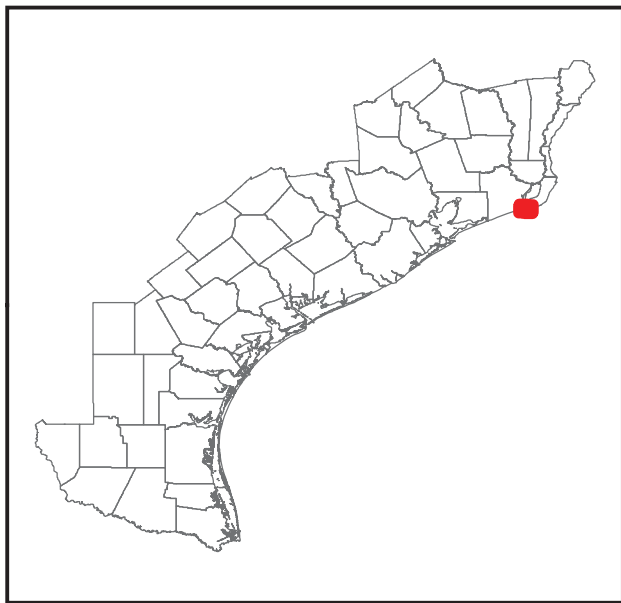

Legend

- Chenier Ridge 1**
- Chenier Ridge 2**
- Chenier Ridge 3**



0 1,300 2,600 5,200 7,800 10,400
Feet

This product is reproduced from geospatial information prepared by the U.S. Army Corps of Engineers. GIS data and product accuracy may vary. Data may be developed from sources of differing accuracy, accurate only at certain scales, based on modeling or interpretation, incomplete while being created or revised, etc. Using GIS products for purposes other than those for which they were created may yield inaccurate or misleading results. The Corps of Engineers reserves the right to correct, update, modify, or replace GIS products without notifications.

Typical Section S-08: Chenier Ridge Restoration

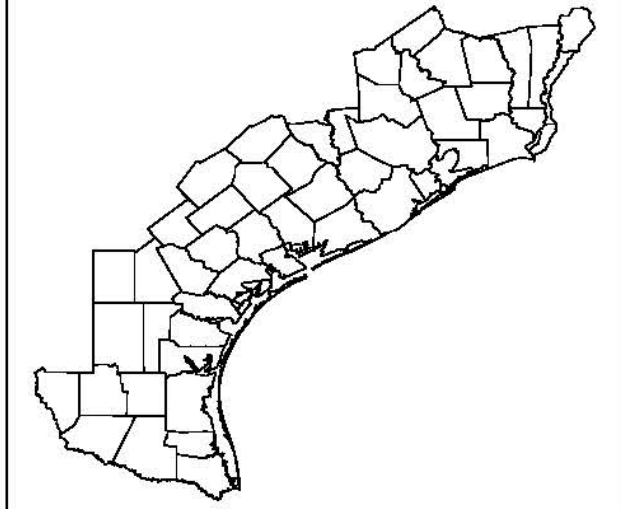
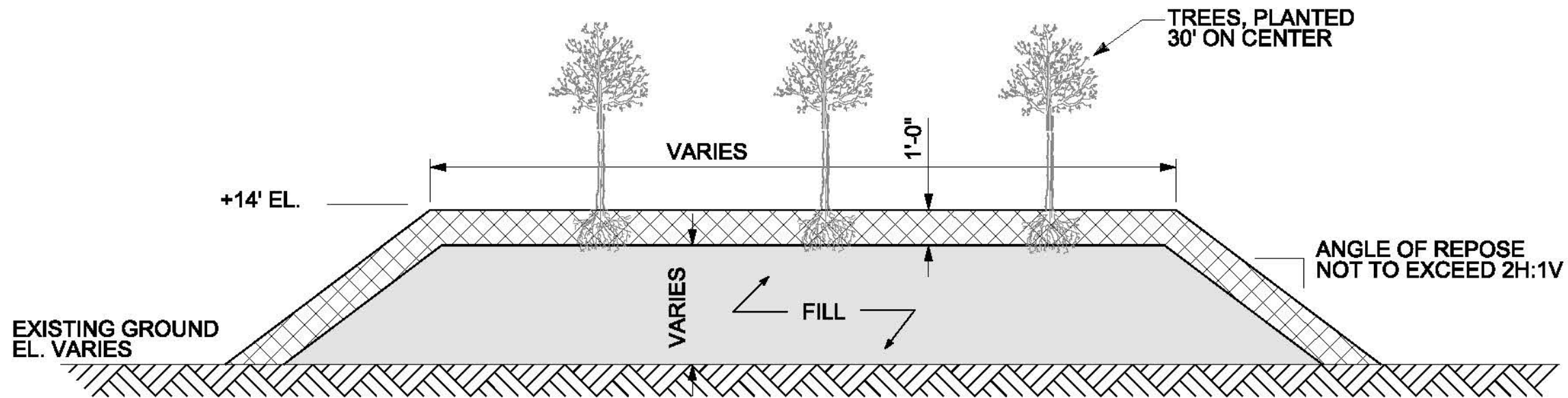

Typical Section S-08

Measure:
5-1

ASSUMPTIONS:

- 1: HYDRAULIC PLACEMENT OF FILL SAND FROM OFFSHORE BORROW SOURCE
- 2: 1 FOOT LAYER OF TOPSOIL SEEDED WITH COASTAL BERMUDA GRASS
- 3: LIVE OAK AND HACKBERRY SEEDLINGS PLANTED 30 FEET ON CENTER



This product is reproduced from geospatial information prepared by the U.S. Army Corps of Engineers. GIS data and product accuracy may vary. Data may be developed from sources of differing accuracy, accurate only at certain scales, based on modelling or interpretation, incomplete while being created or revised, etc. Using GIS products for purposes other than those for which they were created may yield inaccurate or misleading results. The Corps of Engineers reserves the right to correct, update, modify, or replace GIS products without notifications.

Date Created: 4/24/2013



SABINE PASS TO GALVESTON BAY, TEXAS
MEASURE 5-2
INFORMATION SHEET

DESCRIPTION OF MEASURE 5-2 Beneficial Use (BU) of Dredged Material for Shoreline Nourishment at Texas Point, Jefferson County

This measure involves the beneficial use of dredged material from the Sabine-Neches Waterway (SNWW) project for shoreline nourishment at Texas Point near Sabine Pass. The maintenance material would be hydraulically pumped from the adjacent Sabine Pass Channel onto three miles of shoreline on the west side of Sabine Pass. An estimated 977,900 cubic yards would be deposited every six years for fifty years according to the SNWW Channel Improvement Feasibility Study.

LOCATION OF MEASURES (See attached drawings)

Measure 5-2: Jefferson County – BU of Dredged Material from SNWW for Beach Nourishment.pdf

Typical Section S-09: Beach Dune And Beach Renourishment

DESIGN ASSUMPTIONS

- Construction method based on assumptions developed for the SNWW study (USACE, 2011).
- Dredge material would be pumped on the shoreline in a swath 100 ft wide.
- Historic dredging records indicate that the maintenance material from Sabine Pass will average 51 percent silt, 31 percent clay, and 18 percent fine sand (USACE dredging data base).
- Maintenance material from every maintenance cycle of the Sabine Pass Channel (approximately 3-year long cycle) would be hydraulically pumped onto the first beach ridge at Texas Point for a length of approximately 3 miles. The unconfined release of material would be expected to flow into the existing marsh and the Gulf of Mexico surfzone.
- This measure would provide a regular source of predominantly fine-grained sediment that would contribute to mudflat accretion and periodically move onshore to become shore-attached while also providing sediment to raise and nourish eroding marsh at Texas Point.

- The fine-grained sediments are expected to initially be highly mobile and some portion of the material will be rapidly lost from the vicinity of the shoreline. Because of the prevailing wave climate, the mobile material within the surf zone should generally migrate to the west and move toward the eroding shoreline at Texas Point. There, the additional fine-grained sediments could lower erosion rates through mudflat accretion and wave attenuation processes. A small quantity of material may migrate to the east and contribute to the Sabine fillet at the west jetty.

HYDRAULICS & HYDROLOGY

No H&H analysis was performed for this phase of the study. The location and size of the shoreline to be restored is based on shoreline erosion data from the Bureau of Economic Geology (2012) and on the USACE SNWW Feasibility Study (2011).

REAL ESTATE

A detailed breakdown of Real Estate costs can be found in the supplemental document 'Sabine Pass to Galveston Bay, Texas Preliminary Real Estate Cost Estimate'.

- Measure 5-2 BU of Dredge Material for Shoreline Nourishment at Texas Point, Jefferson County.
Total Estimated Real Estate Cost: \$17,100,000 ®

ENVIRONMENTAL

This measure is located entirely within the Texas Point National Wildlife Refuge (NWR) which is undergoing severe shoreline erosion, with net long-term shoreline retreat ranging between 8.2 and 16.4 ft per year. This is one of the highest rates of shoreline loss on the upper Texas coast and a state “critical erosion area.” The current shoreline is a narrow beach front of silty clay that lies seaward of eroding overwash marsh terraces. Given the unusual characteristics of this sand-starved system, returning the material to the littoral system is likely to have a net beneficial effect, regardless of material type. The longshore transport in this system contains primarily fine-grained sediments, but these sediments have been shown to accumulate in the near shore zone and result in shoreline accretion by, as yet, poorly understood processes. The presence of additional fine-grained sediments in the littoral system should reduce the current erosion rate as the presence of additional muddy sediment in the nearshore environment may attenuate waves and lessen wave-induced erosion. Based on these assumptions, it has been estimated that the periodic nourishment would nourish and restore approximately 250 acres of marsh along the

shoreline over a 50 year period of analysis, while substantially reducing the current erosion rate at the placement site and on down drift shorelines, where even higher rates of erosion occur.

BENEFITS

All benefits are assumed be environmental for this phase of analysis.

COSTS

This cost does not include Real Estate. The estimated cost for this measure is \$239,109,600.

REFERENCE DOCUMENTS

USACE. 2011. Final Feasibility Study and Environmental Impact Statement for the Sabine-Neches Waterway Channel Improvement Project, Southeast Texas and Southwest Louisiana. Galveston District.

Bureau of Economic Geology. 2012. Texas Shoreline Change Atlas – <http://igor.beg.utexas.edu/SCA/>

RISKS

- Geotechnical and structural feasibility of the proposal was not reviewed.
- No review of available public information or data from in-house files relative to the general geology and soil conditions for the proposed features was conducted.
- Maintenance material dredged from SNWW does not contain beach quality sand. The fine-grained sediments are expected to initially be highly mobile and some portion of the material will be rapidly lost from the vicinity of the shoreline.
- Implementation of this measure would require a revised Dredged Material Management Plan (DMMP) for the existing SNWW navigation project. Additional document preparation and coordination through USACE O&M would likely be required.
- The behavior of the BU sediments within this complex littoral system cannot be predicted with certainty over the period of analysis, especially given the potential for strong storms to affect the coastal environment. However, there is sufficient knowledge of general processes and baseline conditions to support evaluation of potential impacts and benefits. Furthermore, the engineering feasibility and potential environmental benefits have been demonstrated by successful recent BU projects at Texas and Louisiana Points.

Measure 5-2: BU of Dredged Material for Shoreline Nourishment at Texas Point, Jefferson County

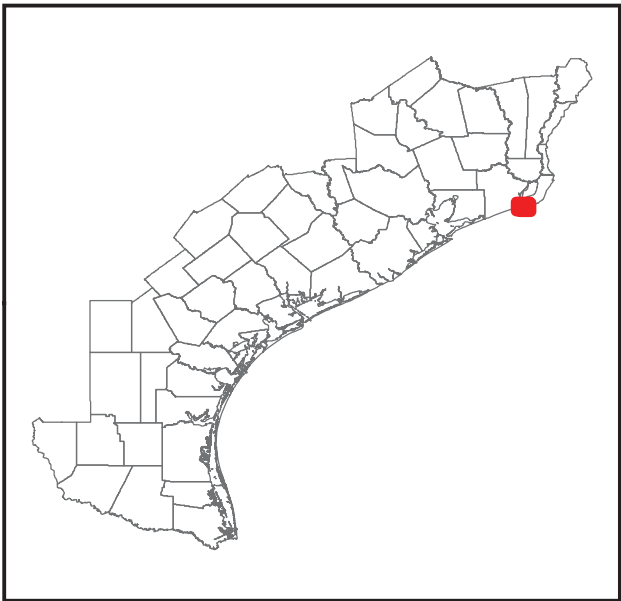

Legend

 **Beach Nourishment**



0 1,350 2,700 5,400 8,100 10,800 Feet



This product is reproduced from geospatial information prepared by the U.S. Army Corps of Engineers. GIS data and product accuracy may vary. Data may be developed from sources of differing accuracy, accurate only at certain scales, based on modeling or interpretation, incomplete while being created or revised, etc. Using GIS products for purposes other than those for which they were created may yield inaccurate or misleading results. The Corps of Engineers reserves the right to correct, update, modify, or replace GIS products without notifications.

Typical Section S-09: Beach Dune And Beach Renourishment

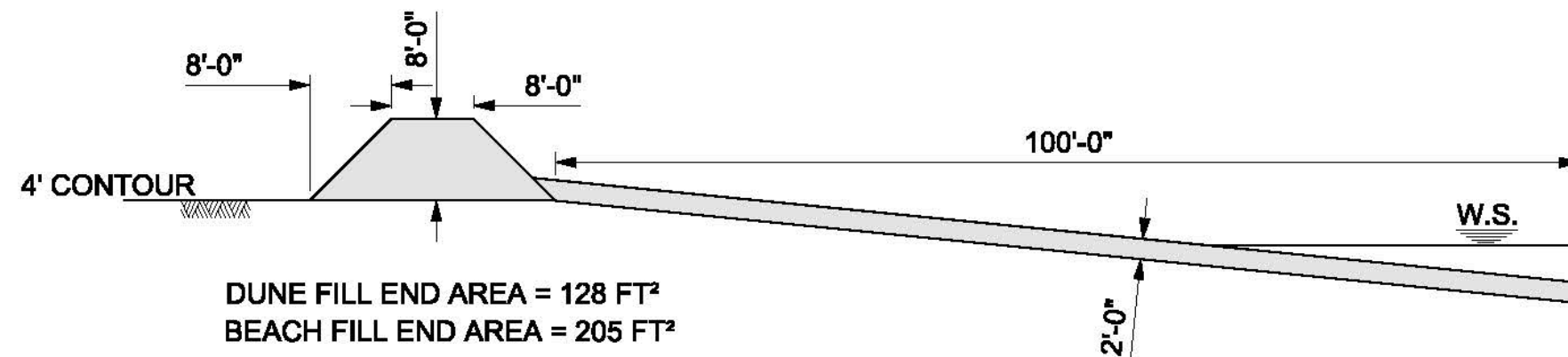

ASSUMPTIONS:

- 1: FILL IS LOOSELY PLACED NON COMPACTED
- 2: FILL IS TRUCKED IN HAUL DISTANCE IS 5 MILES
- 3: DUNE TEMPLATE IS FOUNDED ON THE 4FT CONTOUR
- 4: BEACH FILL IS A UNIFORM 2FT THICKNESS OVER 100FT
- 5: VOLUME IS BASED ON CROSS SECTION AREA MULTIPLIED BY LENGTH

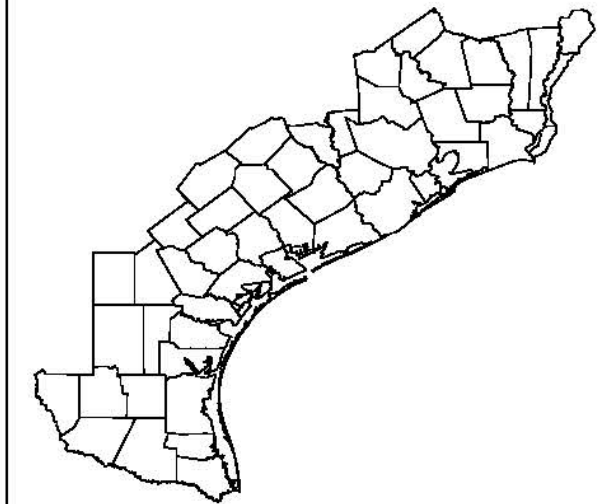

Typical Section S-09

Measures:

- 5-2 (No Dune Construction)
- 5-3
- 5-6
- 5-7 (No Dune Construction)
- 5-8
- 5-11
- 5-12
- 5-13
- 5-14



This product is reproduced from geospatial information prepared by the U.S. Army Corps of Engineers. GIS data and product accuracy may vary. Data may be developed from sources of differing accuracy, accurate only at certain scales, based on modelling or interpretation, incomplete while being created or revised, etc. Using GIS products for purposes other than those for which they were created may yield inaccurate or misleading results. The Corps of Engineers reserves the right to correct, update, modify, or replace GIS products without notifications.

Date Created: 4/24/2013



**SABINE PASS TO GALVESTON BAY, TEXAS
MEASURES 5-3, 5-6, 5-7, 5-8, 5-11, 5-12, and 5-13
INFORMATION SHEET**

DESCRIPTION OF MEASURES

These measures consist of placing fill material along shoreline regions to provide beach nourishment and dune restoration, with periodic renourishment over a 50 year period of analysis. It is assumed that these measures would stabilize the shoreline and prevent erosion during this time period.

Measure 5-3: Dune Restoration and Beach Nourishment, Sabine Pass to High Island, Jefferson and Chambers Counties. This measure would restore approximately 35 miles of shoreline. The area protected by the shoreline includes the community of Sabine Pass, the McFaddin and Texas Point National Wildlife Refuges (NWR), the J.D. Murphree Wildlife Management Area (WMN), and Sea Rim State Park. Just inland of the protected coastal marshlands lies the city of Port Arthur and the largest oil refinery in the United States (Motiva). With the exception of a small sandy beach at Sea Rim State Park, all of this shoreline is an eroding marsh face with little or no sand Gulfward of the marsh. The erosion rate ranges from moderate (average of -4.1 feet/year) to very high (-24.6 feet/year), except near the West Sabine Jetty, where a short section of shoreline is aggrading.

Measure 5-6: Dune Restoration and Beach Nourishment, High Island to Galveston East Jetty, Galveston County. This measure would restore approximately 25.4 miles of shoreline. The area protected by the shoreline includes the entire Bolivar Peninsula and several beach communities such as Gilchrist, Crystal Beach and Port Bolivar. This area was completely destroyed by Hurricane Ike. Some of the community and residential structures have been rebuilt and meet minimum FEMA flood elevations standards and building codes. Sandy beaches with degrading beach dunes predominate the shoreline in this measure, which has an moderate average erosion rate of -4.1 feet/year. A short section of the shoreline near the Galveston East Jetty is aggrading.

Measure 5-7: Beach Nourishment, East Galveston Island Seawall, Galveston County. This measure would restore approximately 7 miles of beach located in front of the Seawall on Galveston Island. No dune restoration is proposed for this measure. The measure would increase the resiliency of the existing Galveston Seawall by restoring and maintaining a beach at the toe of the seawall. No nourishment is proposed for the easternmost 3 miles of the Seawall, as the beach in this area is aggrading. The area protected by the measure is the City of Galveston.

Beaches are eroding at a moderate average rate of -4.1 feet/year to a high average rate of -12.3 feet/year. Groins, constructed to capture sand, capture sand on their up-current sides but starve beaches located down current.

Measure 5-8: Dune Restoration and Beach Nourishment, West Galveston Island, Galveston County. This measure would restore approximately 18.4 miles of Galveston Island west of the Galveston Seawall. The area protected by the shoreline includes the communities or neighborhoods of Pirate's Beach, Jamaica Beach, the Silverleaf Seaside Resort, Vista Del Mar, Terramar, and Baywater, among others. Beaches in this area are eroding at a moderate rate of -4.1 feet/year.

Measure 5-11: Dune Restoration and Beach Nourishment, San Luis Pass to Surfside, Brazoria County. This measure would restore approximately 10.2 miles of shoreline. The area protected by the shoreline includes the narrow barrier peninsula named Follet's Island and its extensive bayside marsh system, one large community named Treasure Island, and other scattered residential developments. Follet's Island also protects a series of extremely productive bays (Bastrop, Christmas and Drum bays) and the Brazoria National Wildlife Refuge on the mainland behind this bay system. Beaches and dunes in this area are eroding at a moderate average rate of -4.1 feet/year to a high average rate of -12.3 feet/year.

Measure 5-12: Dune Restoration and Beach Nourishment, Surfside to Brazos River, Brazoria County. This measure would restore approximately 1.9 miles of shoreline extending eastward from near the Freeport East Jetty. The area protected by the shoreline is the City of Surfside. The average erosion rate for this section of shoreline is moderate, an average of -4.1 feet/year. But within one mile of the East Jetty, there has been about 1,125 feet of erosion over the last 50 years (CHE 2008). The erosion in the area near the jetty is increasing in large part because of the erosion and collapse of the Brazos River delta. The collapse of the delta is the result, in large part, of the construction of the Brazos River Diversion Channel, a USACE project completed in the 1930's. Erosion of the delta began immediately upon completion of the diversion, and the submerged delta face is now located close to shore, increasing wave energy on the Surfside shoreline.

Measure 5-13: Dune Restoration and Beach Nourishment Brazos River to Brazos River Diversion Channel, Brazoria County. This measure would restore approximately 6.3 miles of shoreline. The area protected by this shoreline includes two popular recreation areas at Quintana and Bryan Beaches, the Justin Hurst WMA and several industrial facilities and placement areas. Beach erosion rates in this area range from moderate to very high, with the majority being in the high average rate of -12.3 feet/year.

LOCATION OF MEASURES (See attached drawings)

- Measures 5-3, 5-6, 5-7, 5-8, 5-11, 5-12, 5-13:
- Typical Section S-09: Beach Dune And Beach Renourishment
- Measure 5-3: Dune Restoration and Beach Nourishment, Sabine Pass to High Island, Jefferson and Chambers Counties
- Measure 5-6: Dune Restoration and Beach Nourishment, High Island to Galveston East Jetty, Galveston County
- Measure 5-7: Dune Restoration and Beach Nourishment, East Galveston Island Seawall, Galveston Island
- Measure 5-8: Dune Restoration and Beach Nourishment, West Galveston Island, Galveston County
- Measure 5-11: Dune Restoration and Beach Nourishment, San Luis Pass to Surfside, Brazoria County
- Measure 5-12: Dune Restoration and Beach Nourishment, Surfside to Brazos River, Brazoria County
- Measure 5-13: Dune Restoration and Beach Nourishment, Brazos River to Brazos River Diversion channel, Brazoria County

DESIGN ASSUMPTIONS

- Dune and beach fill will be obtained from the same source.
- A 5 mile round trip haul distance from fill source to location.
- Using 12 CY dump trucks.
- Material placed by dozer, with no additional compaction measures needed.
- Area of beach nourishment is approximately 100 ft wide x 2 ft high per plan typical.
- The dune section will be trapezoidal 8 ft high with a 24 ft wide base per plan typical.

Measure	Fill Estimate (CY)
5-3	2,244,667
5-6	1,652,667
5-7	280,926
5-8	1,196,333
5-11	666,000
5-12	246,667
5-13	407,000

HYDRAULICS & HYDROLOGY

No H&H analysis was performed for this phase of the study. The location and size of the shoreline to be restored is based on shoreline erosion data from the Bureau of Economic Geology (2012).

REAL ESTATE REQUIREMENTS

A detailed breakdown of Real Estate costs can be found in the supplemental document 'Sabine Pass to Galveston Bay, Texas Preliminary Real Estate Cost Estimate'.

- Measure 5-3: Dune Restoration and Beach Nourishment, Sabine Pass to High Island, Jefferson and Chambers Counties.
Total Estimated Real Estate Cost: \$17,900,000 ®

- Measure 5-6: Dune Restoration and Beach Nourishment, High Island to Galveston East Jetty, Galveston County
Total Estimated Real Estate Cost: \$16,200,000 ®

- Measure 5-7: Beach Nourishment, East Galveston Island Seawall, Galveston County.
Total Estimated Real Estate Cost: \$4,500,000 ®

- Measure 5-8: Dune Restoration and Beach Nourishment, West Galveston Island, Galveston County.
Total Estimated Real Estate Cost: \$11,700,000 ®

- Measure 5-11: Dune Restoration and Beach Nourishment, San Luis Pass to Surfside, Brazoria County.
Total Estimated Real Estate Cost: \$5,400,000 ®

- Measure 5-12: Dune Restoration and Beach Nourishment, Surfside to Brazos River, Brazoria County.
Total Estimated Real Estate Cost: \$1,000,000 ®

- Measure 5-13: Dune Restoration and Beach Nourishment Brazos River to Brazos River Diversion Channel, Brazoria County.
Total Estimated Real Estate Cost: \$3,400,000 ®

ENVIRONMENTAL

Dune restoration and beach nourishment on the Gulf shoreline would initially restore a 125 feet wide dune-beach complex along the shoreline of each measure. Regular beach renourishment (every 5 years) and dune restoration (every 20 years) would ensure that the beach and dune are in place throughout the 50-year period of analysis, as the renourishment rate results in no net loss when compared to the average long-term erosion rate. Therefore, environmental benefits for measures 5-6, 5-7, 5-8, 5-11, and 5-12 are based on the acres of erosion that would be prevented over the 50-year period of analysis. The 50-year estimate of acres lost was estimated using Bureau of Economic Geology (BEG) long-term erosion rates for the Texas coast (BEG, 2012).

Measure 5-3 Dune Restoration and Beach Nourishment, Sabine Pass to High Island, Jefferson and Chambers Counties is different from the other measures in that the dune/beach complex would prevent the Gulf from breaking through and threatening a 50,000 acre coastal wetland that is covered with interconnected lakes and bayous. Erosion of the beach ridge along the McFaddin/Texas Point NWR and Sea Rim State Park property would allow Gulf seawater to wash into interior marshes during high tides and storm surges. This has the potential to cause widespread loss of wetlands in this federally- and state-protected coastal wetland system. The total estimated environmental benefit for this measure (20,200 acres) is the total acres of shoreline erosion that would be prevented over the 50-year period analysis (for the entire measure) plus the wetland acres of the Unit that lie behind the shoreline that would be lost. The entire shoreline of Measure 5-3 protects the McFaddin and Texas Point National Wildlife Refuges, and Sea Rim State Park.

Measure 5-13 Dune Restoration and Beach Nourishment Brazos River to Brazos River Diversion Channel, Brazoria County would protect the Bryan Beach Unit of the Justin Hurst WMA in addition to placement areas, and residential, industrial and recreational development. This Unit is located at the western end of the measure, and accounts for approximately 10 percent of the total shoreline length. The Unit is 440 acres dominated by a 90-acre embayment which is flooded by Gulf waters during high tides and storms. The embayment is separated from the Gulf by a large vegetated coastal dune. Coastal marshes surround the embayment behind the dune. Continued erosion of the embayment shoreline at the long-term rate reported by the Bureau of Economic Geology would result in the complete opening of the embayment and loss of the surrounding coastal marsh. The total estimated environmental benefit for this measure (450 acres) is the total acres of shoreline erosion that would be prevented over the 50-year period analysis (for the entire measure) plus the wetland acres of the Unit that lie behind the shoreline that would be lost.

Measure Description	Length of Shoreline (miles)	Restored Shoreline (acres)	Acres of Erosion Prevented Over 50 Yrs
Measure 5-3 (Sabine Pass to High Island)	35	530	20,200
Measure 5-6 (High Island to Galveston East Jetty)	25.4	385	530
Measure 5-7 (East Galveston Island-Seawall)	7	106	235
Measure 5-8 (West Galveston Island)	18.4	279	420
Measure 5-11 (San Luis Pass to Surfside)	10.2	155	500
Measure 5-12 (Surfside to Brazos River)	1.9	29	45
Measure 5-13 (Brazos River to Brazos River Diversion Channel)	6.3	95	475

BENEFITS:

All benefits are assumed be environmental for this phase of analysis.

COSTS:

These costs do not include Real Estate.

Measure 5-3: Dune Restoration and Beach Nourishment, Sabine Pass to High Island, Jefferson and Chambers Counties The estimated cost for this measure is \$462,912,000.

Measure 5-6: Dune Restoration and Beach Nourishment, High Island to Galveston East Jetty, Galveston County The estimated cost for this measure is \$340,829,000.

Measure 5-7: Dune Restoration and Beach Nourishment, East Galveston Island Seawall, Galveston Island. The estimated cost for this measure is \$95,112,000.

Measure 5-8: : Dune Restoration and Beach Nourishment, West Galveston Island, Galveston County. The estimated cost for this measure is \$246,713,000.

Measure 5-11: Dune Restoration and Beach Nourishment, San Luis Pass to Surfside, Brazoria County. The estimated cost for this measure is \$137,349,000.

Measure 5-12: Dune Restoration and Beach Nourishment, Surfside to Brazos River, Brazoria County. The estimated cost for this measure is \$50,875,000.

Measure 5-13: Dune Restoration and Beach Nourishment, Brazos River to Brazos River Diversion channel, Brazoria County The estimated cost for this measure is \$83,932,000.

REFERENCE DOCUMENTS:

Bureau of Economic Geology (BEG). 2012. Texas Shoreline Change Atlas – <http://igor.beg.utexas.edu/SCA/>

RISKS:

- Geotechnical and Structural feasibility of the proposal was not reviewed.
- No review of available public information or data from in-house files relative to the general geology and soil conditions for the proposed features was conducted.
- Shoreline erosion rates are based on the midpoint of long-term erosion rate ranges that have been measured by the Bureau of Economic Geology at the University of Texas at Austin. Actual erosion rates may be lower or higher than the estimate. Additionally, these erosion rates are based on historical data and do not account for any increase in the rate of relative sea level rise that may be occur in conjunction with climate change.

Measure 5-3: Jefferson County - Restore Beach Ridge - Sabine Pass to High Island

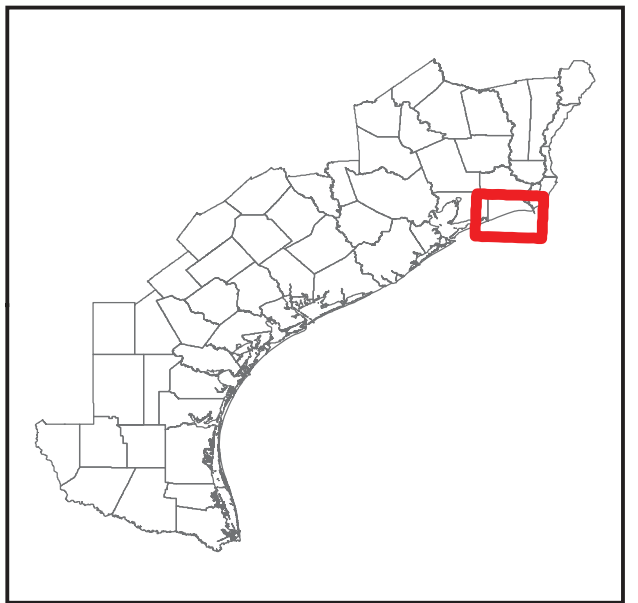
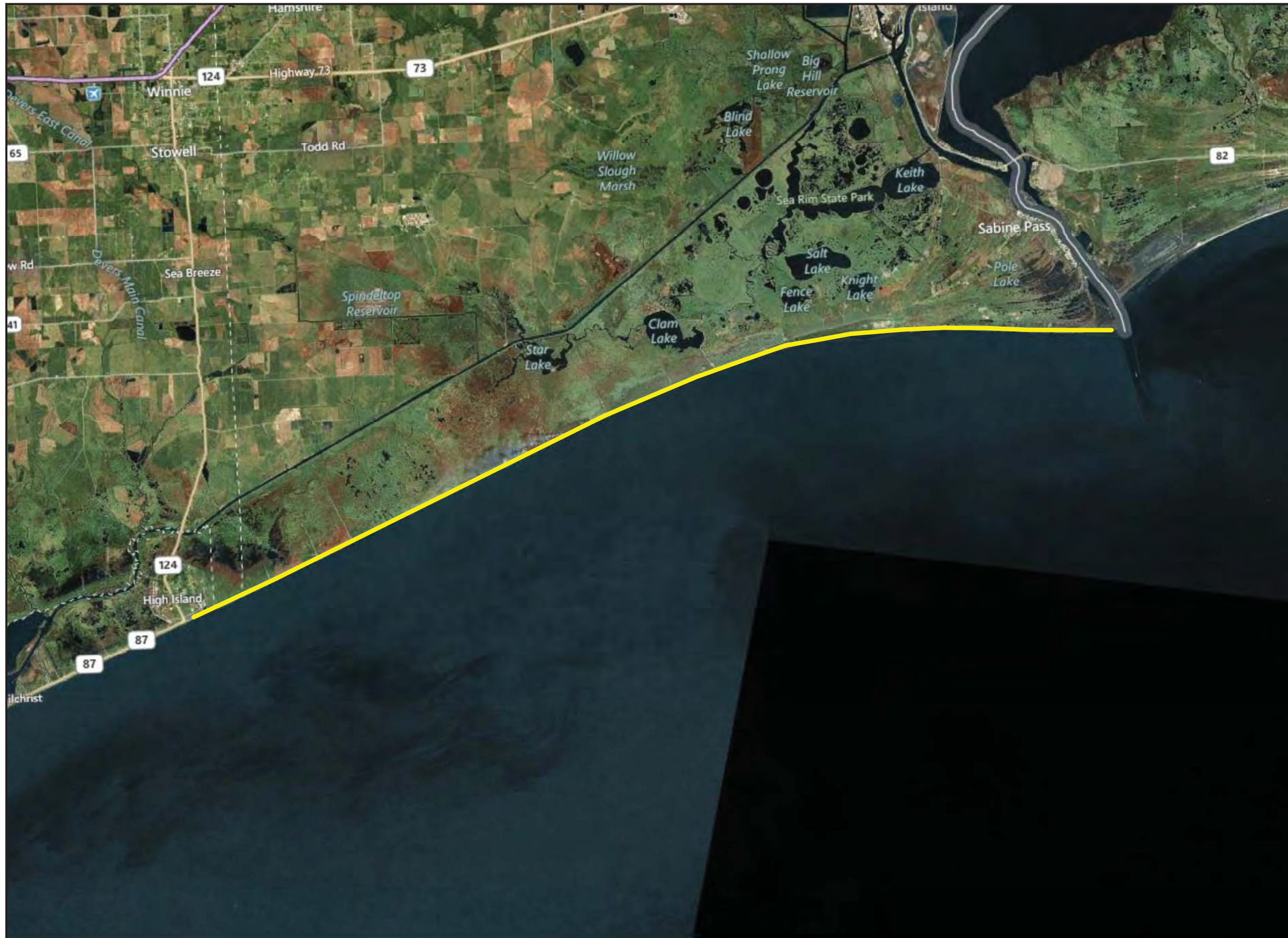

Legend

 Clay Core Dune



This product is reproduced from geospatial information prepared by the U.S. Army Corps of Engineers. GIS data and product accuracy may vary. Data may be developed from sources of differing accuracy, accurate only at certain scales, based on modeling or interpretation, incomplete while being created or revised, etc. Using GIS products for purposes other than those for which they were created may yield inaccurate or misleading results. The Corps of Engineers reserves the right to correct, update, modify, or replace GIS products without notifications.

Date Created: 2/26/2013



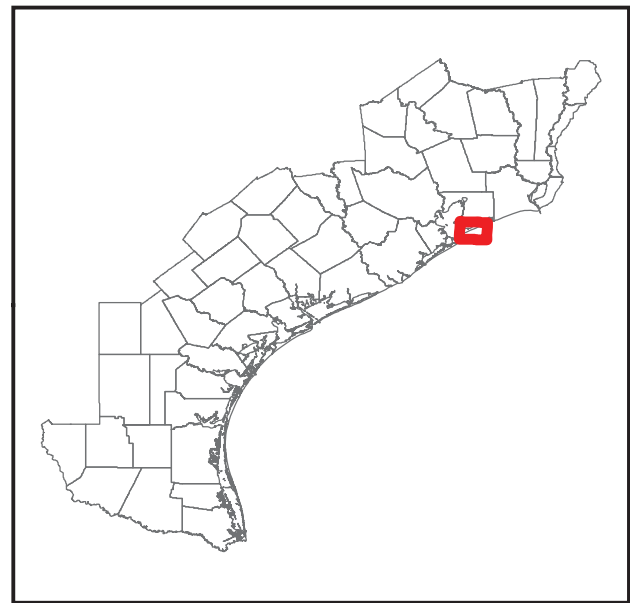

Measure 5-6: Galveston County - Dune and Beach Nourishment - High Island to Bolivar



Legend

 Dune and Beach Renourishment





0 2,500 5,000 10,000 15,000 20,000 Feet

This product is reproduced from geospatial information prepared by the U.S. Army Corps of Engineers. GIS data and product accuracy may vary. Data may be developed from sources of differing accuracy, accurate only at certain scales, based on modeling or interpretation, incomplete while being created or revised, etc. Using GIS products for purposes other than those for which they were created may yield inaccurate or misleading results. The Corps of Engineers reserves the right to correct, update, modify, or replace GIS products without notifications.

Date Created: 2/26/2013



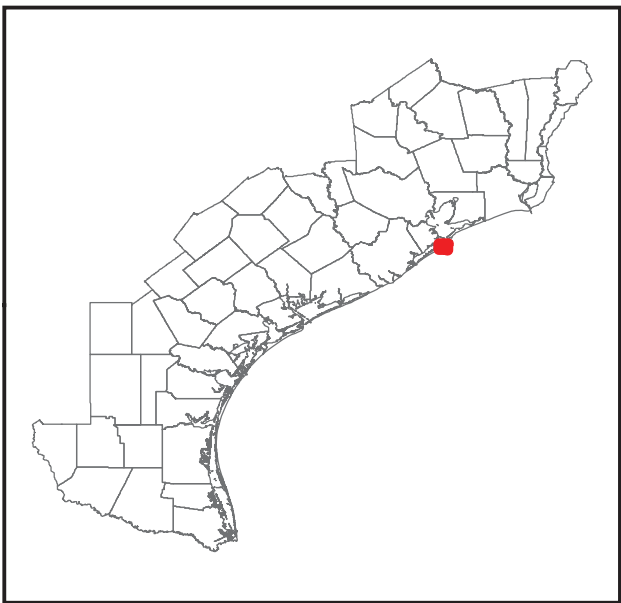
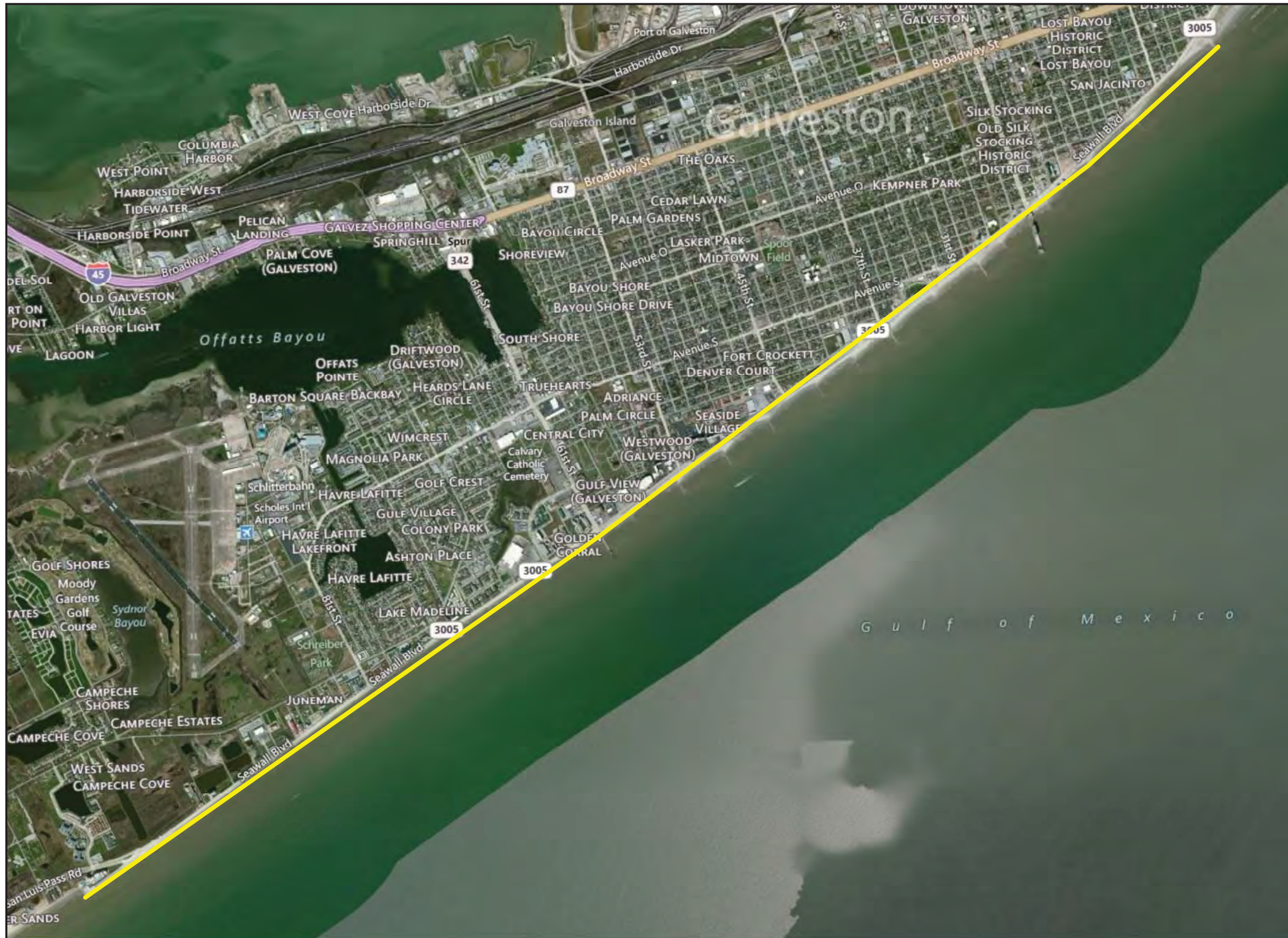

Measure 5-7: Galveston County - Beach Renourishment - East Galveston in front of Seawall



Legend

 Beach Renourishment





0 850 1,700 3,400 5,100 6,800 Feet

This product is reproduced from geospatial information prepared by the U.S. Army Corps of Engineers. GIS data and product accuracy may vary. Data may be developed from sources of differing accuracy, accurate only at certain scales, based on modeling or interpretation, incomplete while being created or revised, etc. Using GIS products for purposes other than those for which they were created may yield inaccurate or misleading results. The Corps of Engineers reserves the right to correct, update, modify, or replace GIS products without notifications.

Date Created: 2/26/2013



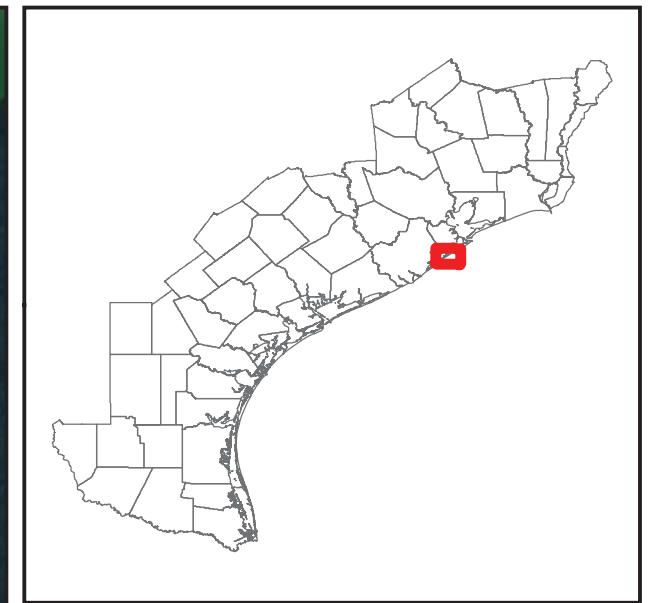

Measure 5-8: Galveston County - Dune Restoration and Beach Nourishment - Galveston West End



Legend

 Dune and Beach Nourishment





0 2,300 4,600 9,200 13,800 18,400 Feet

This product is reproduced from geospatial information prepared by the U.S. Army Corps of Engineers. GIS data and product accuracy may vary. Data may be developed from sources of differing accuracy, accurate only at certain scales, based on modeling or interpretation, incomplete while being created or revised, etc. Using GIS products for purposes other than those for which they were created may yield inaccurate or misleading results. The Corps of Engineers reserves the right to correct, update, modify, or replace GIS products without notifications.

Date Created: 2/26/2013



Measure 5-11: Brazoria County – Dune Restoration and Beach Nourishment - Follets Island

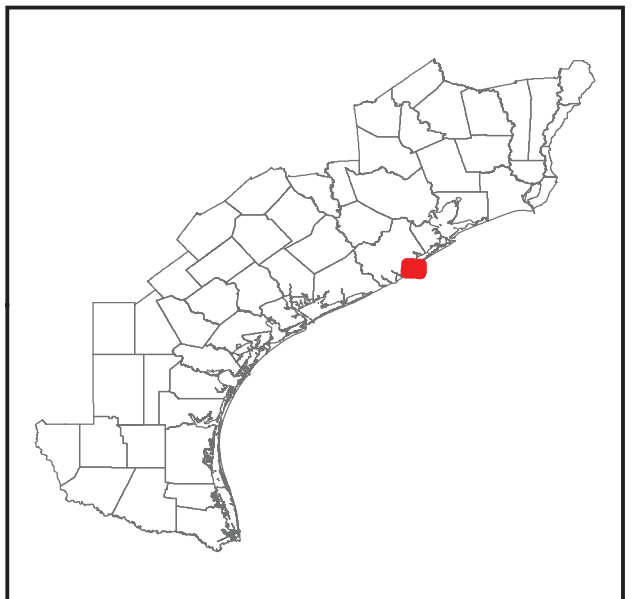

Legend

 Dune and Beach Nourishment



This product is reproduced from geospatial information prepared by the U.S. Army Corps of Engineers. GIS data and product accuracy may vary. Data may be developed from sources of differing accuracy, accurate only at certain scales, based on modeling or interpretation, incomplete while being created or revised, etc. Using GIS products for purposes other than those for which they were created may yield inaccurate or misleading results. The Corps of Engineers reserves the right to correct, update, modify, or replace GIS products without notifications.

Date Created: 2/26/2013



Measure 5-12: Dune Restoration and Beach Nourishment, Surfside to Brazos River, Brazoria County

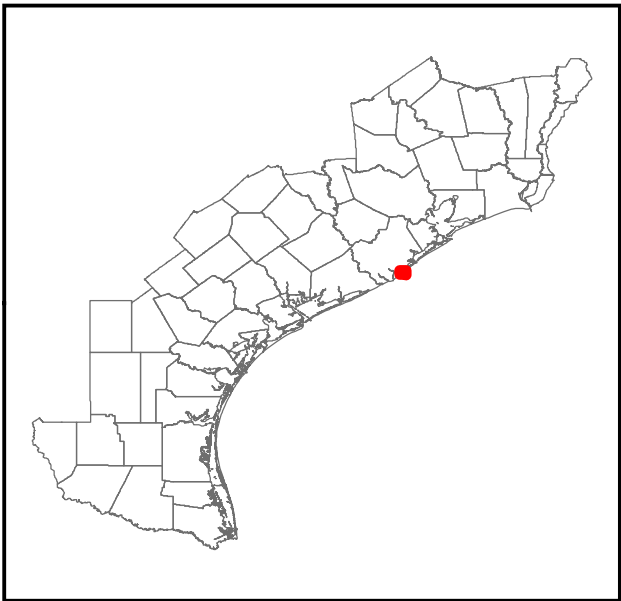
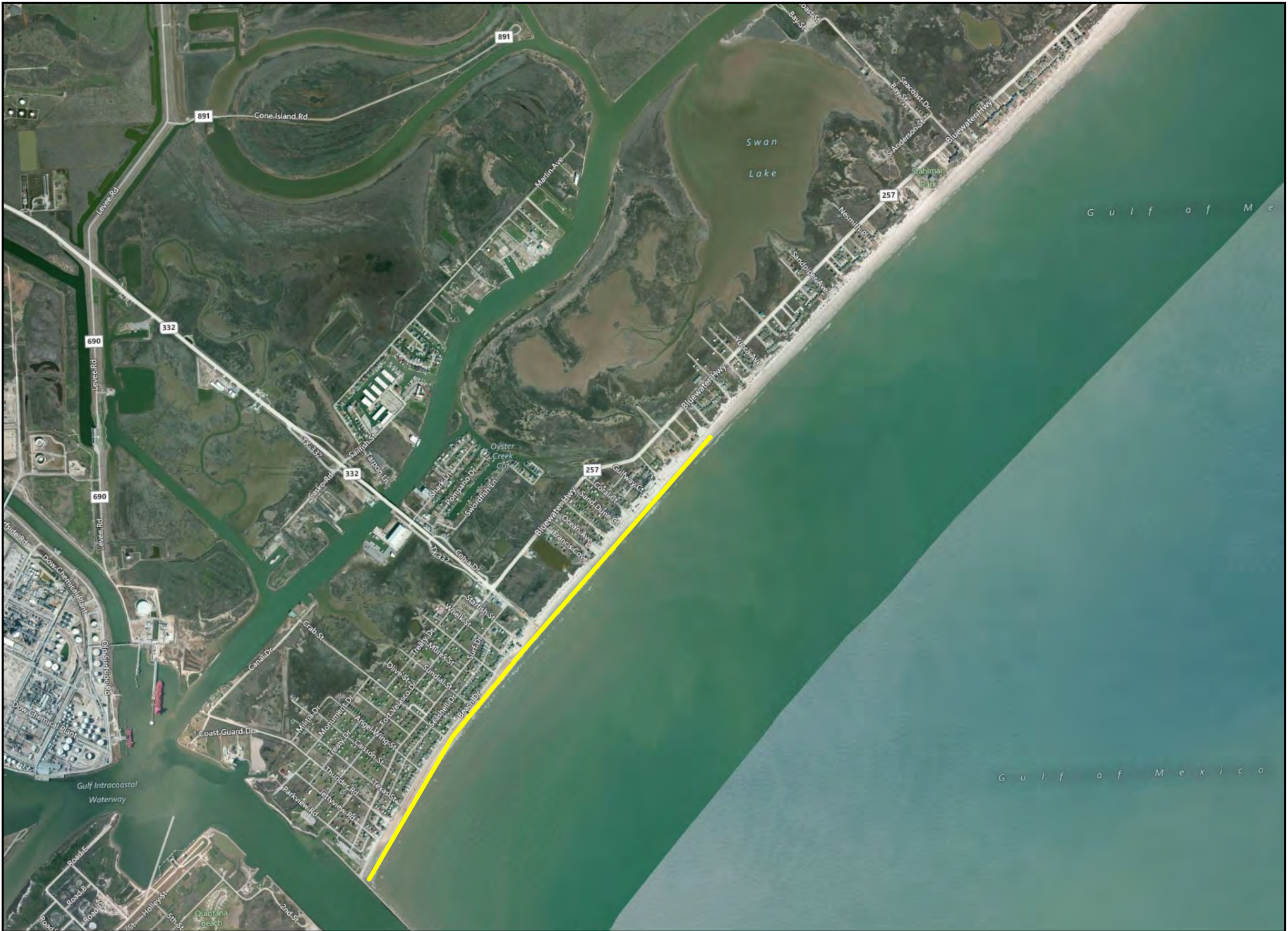

Legend

— Dune and Beach Nourishment

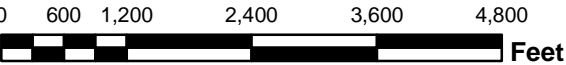

 0 600 1,200 2,400 3,600 4,800 Feet

This product is reproduced from geospatial information prepared by the U.S. Army Corps of Engineers. GIS data and product accuracy may vary. Data may be developed from sources of differing accuracy, accurate only at certain scales, based on modeling or interpretation, incomplete while being created or revised, etc. Using GIS products for purposes other than those for which they were created may yield inaccurate or misleading results. The Corps of Engineers reserves the right to correct, update, modify, or replace GIS products without notifications.

Date Created: 5/29/2013

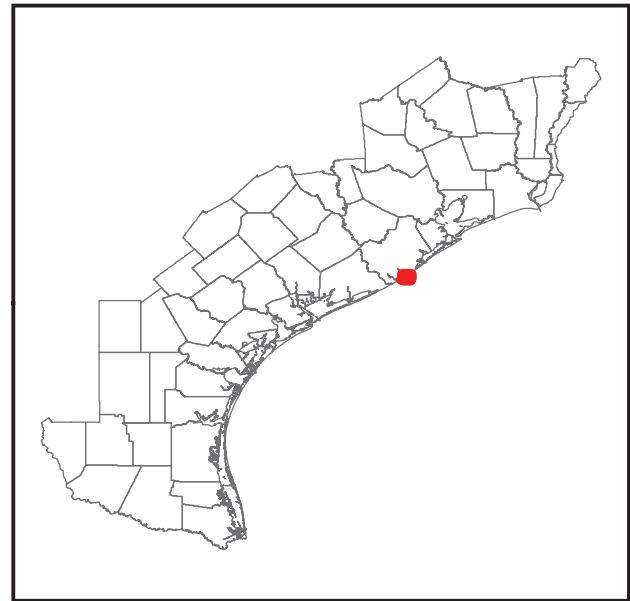
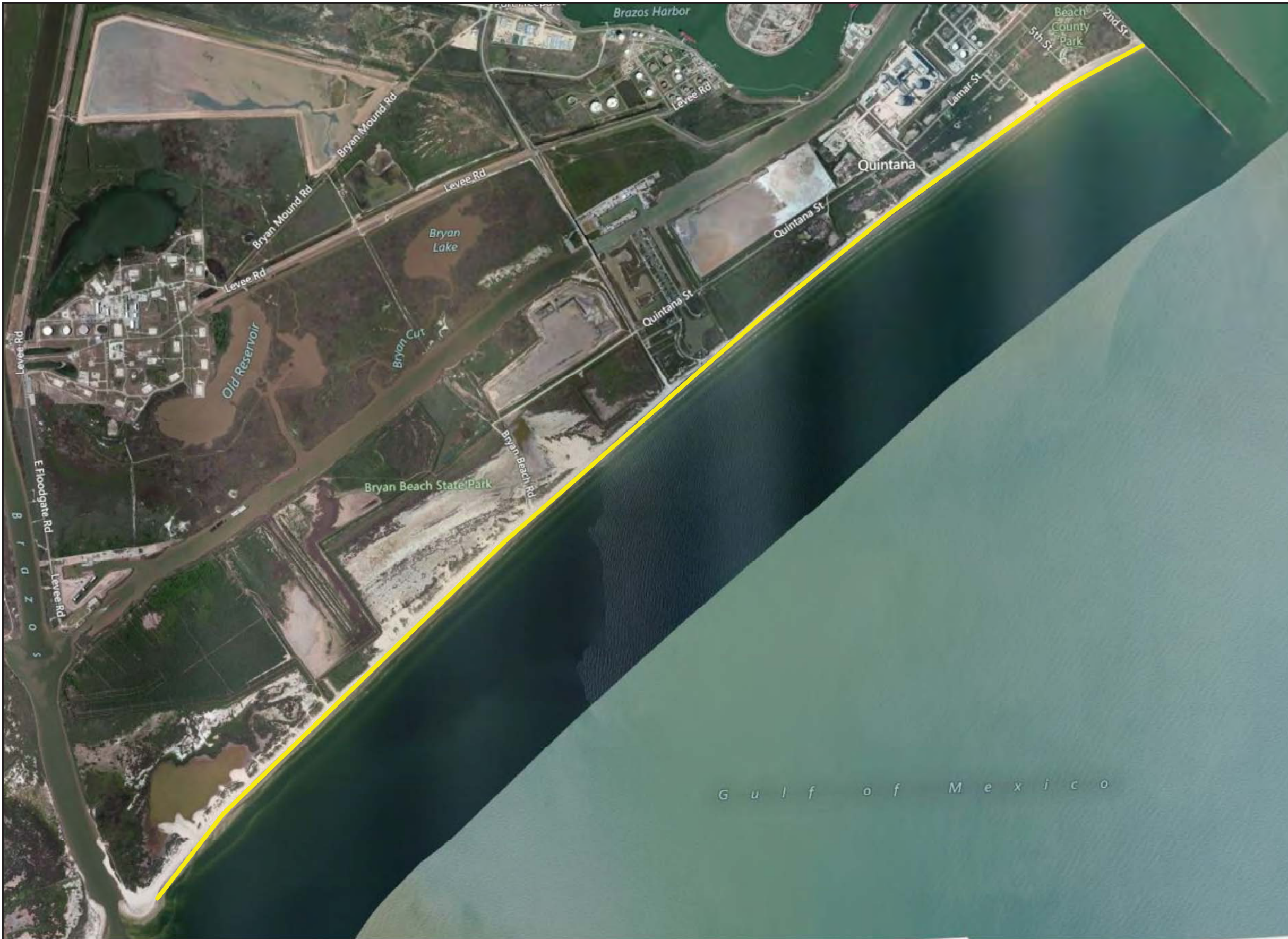

Measure 5-13: Brazoria County - Dune Restoration and Beach Nourishment – Quintana



Legend

 Dune and Beach Nourishment

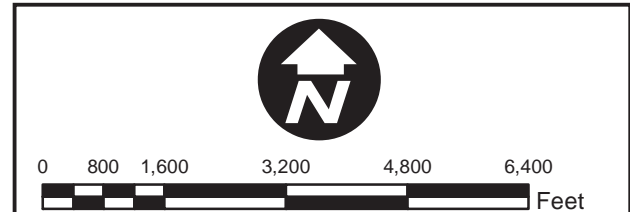

This product is reproduced from geospatial information prepared by the U.S. Army Corps of Engineers. GIS data and product accuracy may vary. Data may be developed from sources of differing accuracy, accurate only at certain scales, based on modeling or interpretation, incomplete while being created or revised, etc. Using GIS products for purposes other than those for which they were created may yield inaccurate or misleading results. The Corps of Engineers reserves the right to correct, update, modify, or replace GIS products without notifications.

Typical Section S-09: Beach Dune And Beach Renourishment

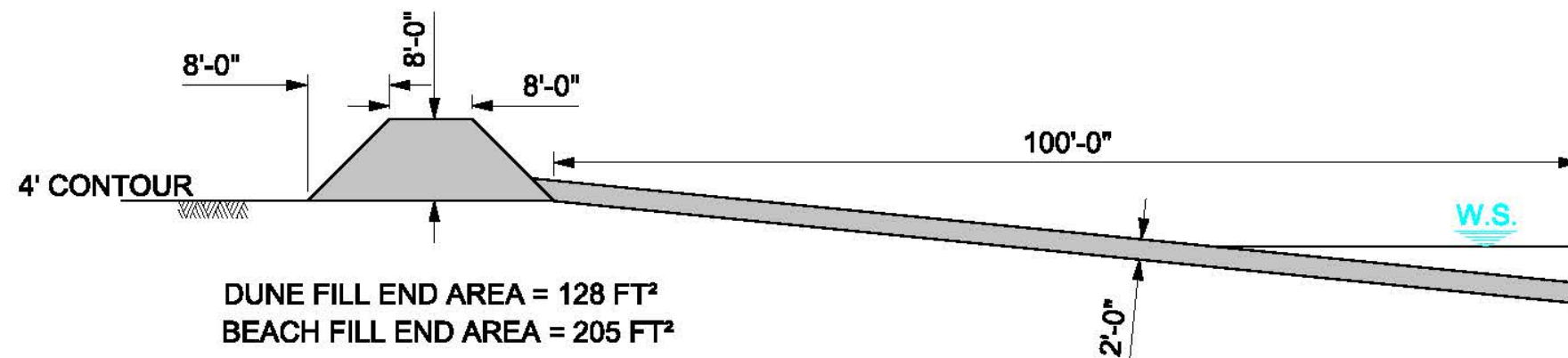

ASSUMPTIONS:

- 1: FILL IS LOOSELY PLACED NON COMPACTED
- 2: FILL IS TRUCKED IN HAUL DISTANCE IS 5 MILES
- 3: DUNE TEMPLATE IS FOUNDED ON THE 4FT CONTOUR
- 4: BEACH FILL IS A UNIFORM 2FT THICKNESS OVER 100FT
- 5: VOLUME IS BASED ON CROSS SECTION AREA MULTIPLIED BY LENGTH

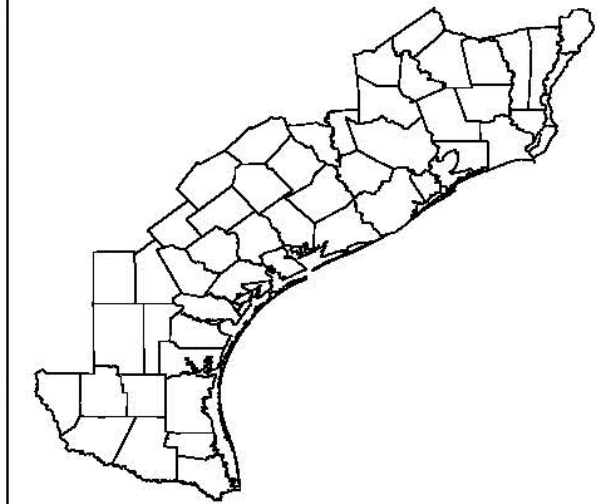

Typical Section S-09

Measures:

- 5-2 (No Dune Construction)
- 5-3
- 5-6
- 5-7 (No Dune Construction)
- 5-8
- 5-11
- 5-12
- 5-13
- 5-14



This product is reproduced from geospatial information prepared by the U.S. Army Corps of Engineers. GIS data and product accuracy may vary. Data may be developed from sources of differing accuracy, accurate only at certain scales, based on modeling or interpretation, incomplete while being created or revised, etc. Using GIS products for purposes other than those for which they were created may yield inaccurate or misleading results. The Corps of Engineers reserves the right to correct, update, modify, or replace GIS products without notifications.

Date Created: 4/15/2013



**SABINE PASS TO GALVESTON BAY, TEXAS
MEASURES 5-5, 5-9, 5-15
INFORMATION SHEET**

DESCRIPTION OF MEASURES

Measure 5-5: Segmented Nearshore Breakwaters, Sabine Pass to High Island, Jefferson and Chambers Counties

Measure 5-9: Segmented Nearshore Breakwaters, West Galveston Island to San Luis Pass

Measure 5-15: Segmented Nearshore Breakwaters, San Luis Pass to Brazos River Diversion Channel, Brazoria County

All three of these measures involve gulf shoreline protection and restoration using riprap to create segmented nearshore breakwaters and one initial episode of beach nourishment. In conjunction with the beach nourishment, a sand fence would be added on shore along the vegetation line to keep the sand within the beach zone. It is assumed that these measures would stabilize the shoreline and prevent erosion during the 50 year period of analysis.

LOCATION OF MEASURES (See attached drawings)

Measure 5-5: Segmented Nearshore Breakwaters, Sabine Pass to High Island, Jefferson and Chambers Counties

Measure 5-9: Segmented Nearshore Breakwaters, West Galveston Island to San Luis Pass

Measure 5-15: Segmented Nearshore Breakwaters, San Luis Pass to Brazos River Diversion Channel, Brazoria County.

DESIGN ASSUMPTIONS

- Breakwaters are 150 ft long spaced at 300 ft apart.
- Riprap breakwater is placed in 5ft deep water.
- The breakwater would be trapezoidal 10ft high with a 50 ft wide base per plan typical. See cross section details on plan sheet S4.
- Riprap will be barged in to site. It will also be placed from the barge.
- A 10 ft deep flow channel will need to be excavated for rock barge access.
- Measures 5-5: Length = 182,000 ft; Volume of stone = 674,074 cy.

- Measures 5-9: Length = 137,000 ft; Volume of stone = 507,407 cy.
- Measures 5-15: Length = 110,000 ft; Volume of stone = 407,407 cy.
- Beach fill would be obtained from the same source.
- A 5 mile round trip haul distance from fill source to location.
- Using 12 CY dump trucks.
- Material placed by dozer, with no additional compaction measures needed.
- Area of beach nourishment is approximately 100 ft wide x 2 ft high per plan typical.
- The dune section will be trapezoidal 8 ft high with a 24 ft wide base per plan typical. Sand fence placed along established dune line or 100' from shoreline if dunes are not present.

HYDRAULICS & HYDROLOGY

No H&H analysis was performed for this phase of the study. The location of these measures is based on shoreline erosion data from the Bureau of Economic Geology (2012).

REAL ESTATE

A detailed breakdown of Real Estate costs can be found in the supplemental document 'Sabine Pass to Galveston Bay, Texas Preliminary Real Estate Cost Estimate'. Costs identified as \$0 are generally associated with Federal and/or State lands.

- Measure 5-5: Segmented Nearshore Breakwaters, Sabine Pass to High Island, Jefferson and Chambers Counties
Total Estimated Real Estate Cost: \$6,904,000 ®
- Measure 5-9 Segmented Nearshore Breakwaters, West Galveston Island to San Luis Pass
Total Estimated Cost of Measure 5-9: \$0
- Measure 5-15: Segmented Nearshore Breakwaters, San Luis Pass to Brazos River Diversion Channel, Brazoria County
Total Estimated Real Estate Cost of Measure 5-15: \$5,200,000 ®

ENVIRONMENTAL

Nearshore breakwaters and beach nourishment on the Gulf shoreline would initially restore a 100 feet wide beach along the shoreline of each measure. Regular beach renourishment (every 5 years) would ensure that the beach and dune are in place throughout the 50-year period of analysis, as the renourishment rate results in no net loss when compared to the average long-term erosion rate. Therefore, environmental benefits for measures 5-5, 5-9, and 5-15 are based on the acres of erosion that would be prevented over the 50-year period of analysis. The 50-year

estimate of acres lost was estimated using Bureau of Economic Geology (BEG) long-term erosion rates for the Texas coast (BEG, 2012).

Measure 5-5 Segmented Nearshore Breakwaters, Sabine Pass to High Island, Jefferson and Chambers Counties is different from the other measures in that the breakwater and beach complex would prevent the Gulf from breaking through and threatening a 50,000 acre coastal wetland that is covered with interconnected lakes and bayous. Erosion of the beach ridge along the McFaddin/Texas Point NWR and Sea Rim State Park property would allow Gulf seawater to wash into interior marshes during high tides and storm surges. This has the potential to cause widespread loss of wetlands in this federally- and state-protected coastal wetland system. The total estimated environmental benefit for this measure (20,200 acres) is the total acres of shoreline erosion that would be prevented over the 50-year period analysis (for the entire measure) plus the wetland acres of the Unit that lie behind the shoreline that would be lost. The entire shoreline of Measure 5-5 protects the McFaddin and Texas Point National Wildlife Refuges, and Sea Rim State Park.

Measure 5-9 Segmented Nearshore Breakwaters, West Galveston Island to San Luis Pass, Galveston County would protect and restore the existing beach on West Galveston Island. The majority of area that would be protected by this measure is developed seaside residential development. The environmental benefits are therefore limited to the acres of erosion that would be prevented over the 50-year period of analysis, or 420 acres.

Measure 5-15 Segmented Nearshore Breakwaters, San Luis Pass to Brazos River Diversion Channel, Brazoria County would protect the shoreline of Folletts Island, seaside residential and industrial developments in the communities of Surfside and Quintana, and the Bryan Beach Unit of the Justin Hurst WMA. The Justin Hurst WMA unit is located at the western end of the measure, and accounts for approximately 10 percent of the total shoreline length. The Unit is 440 acres dominated by a 90-acre embayment which is flooded by Gulf waters during high tides and storms. The embayment is separated from the Gulf by a large vegetated coastal dune. Coastal marshes surround the embayment behind the dune. Continued erosion of the embayment shoreline at the long-term rate reported by the Bureau of Economic Geology would result in the complete opening of the embayment and loss of the surrounding coastal marsh. The total estimated environmental benefit for this measure (475 acres) is the total acres of shoreline erosion that would be prevented over the 50-year period analysis (for the entire measure) plus the wetland acres of the Unit that lie behind the shoreline that would be lost.

Measure Description	Length of Shoreline (miles)	Restored Shoreline (acres)	Acres of Erosion Prevented Over 50 Yrs
Measure 5-5 Segmented Nearshore Breakwaters, Sabine Pass to High Island	35	530	20,200
Measure 5-9 Segmented Nearshore Breakwaters, West Galveston Island to San Luis Pass	18.4	279	420
Measure 5-15 Segmented Nearshore Breakwaters, San Luis Pass to Brazos River Diversion Channel	18.4	279	930

BENEFITS

All benefits are assumed be environmental for this phase of analysis.

COSTS

These costs do not include Real Estate.

Measure 5-5: Segmented Nearshore Breakwaters, Sabine Pass to High Island, Jefferson and Chambers Counties. The estimated cost for this measure is \$219,772,000.

Measure 5-9: Segmented Nearshore Breakwaters, West Galveston Island to San Luis Pass. The estimated cost for this measure is \$165,435,000.

Measure 5-15: Segmented Nearshore Breakwaters, San Luis Pass to Brazos River Diversion Channel, Brazoria County. The estimated cost for this measure is \$132,017,000.

REFERENCE DOCUMENTS

Measures 5-5, 5-9 and 5-15: Holly Beach LADNR / CWPRA project website; Engineering Design Manual; There was a revision report for space between breakwaters.

Bureau of Economic Geology (BEG). 2012. Texas Shoreline Change Atlas – <http://igor.beg.utexas.edu/SCA/>

RISKS

- Geotechnical and Structural feasibility of the proposal was not reviewed.
- No review of available public information or data from in-house files relative to the general geology and soil conditions for the proposed features was conducted.
- Area required for sand fence may encroach on private property
- Shoreline erosion rates are based on the midpoint of long-term erosion rate ranges that have been measured by the Bureau of Economic Geology at the University of Texas at Austin. Actual erosion rates may be lower or higher than the estimate. Additionally, these erosion rates are based on historical data and do not account for any increase in the rate of relative sea level rise that may be occur in conjunction with climate change.

Measure 5-5: Jefferson County - Segmented Near-Shore Breakwaters - Sabine Pass to High Island

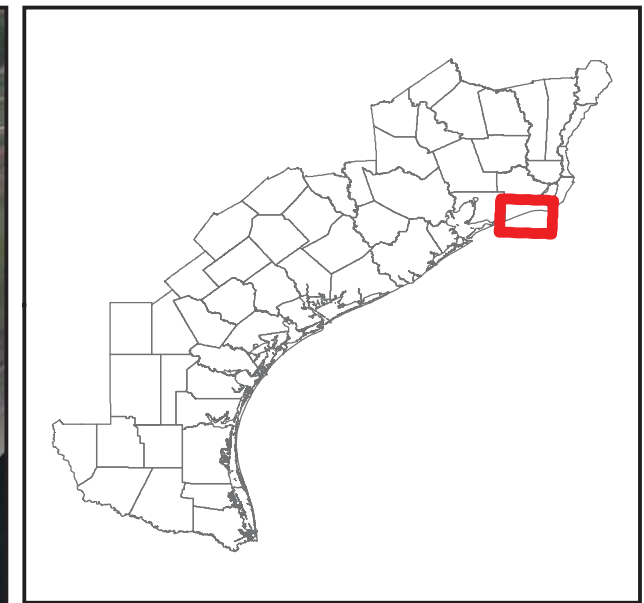

Legend

--- Breakwaters





0 4,850 9,700 19,400 29,100 38,800 Feet

This product is reproduced from geospatial information prepared by the U.S. Army Corps of Engineers. GIS data and product accuracy may vary. Data may be developed from sources of differing accuracy, accurate only at certain scales, based on modeling or interpretation, incomplete while being created or revised, etc. Using GIS products for purposes other than those for which they were created may yield inaccurate or misleading results. The Corps of Engineers reserves the right to correct, update, modify, or replace GIS products without notifications.



Date Created: 2/26/2013

Measure 5-9: Galveston County - Segmented Near-Shore Breakwaters

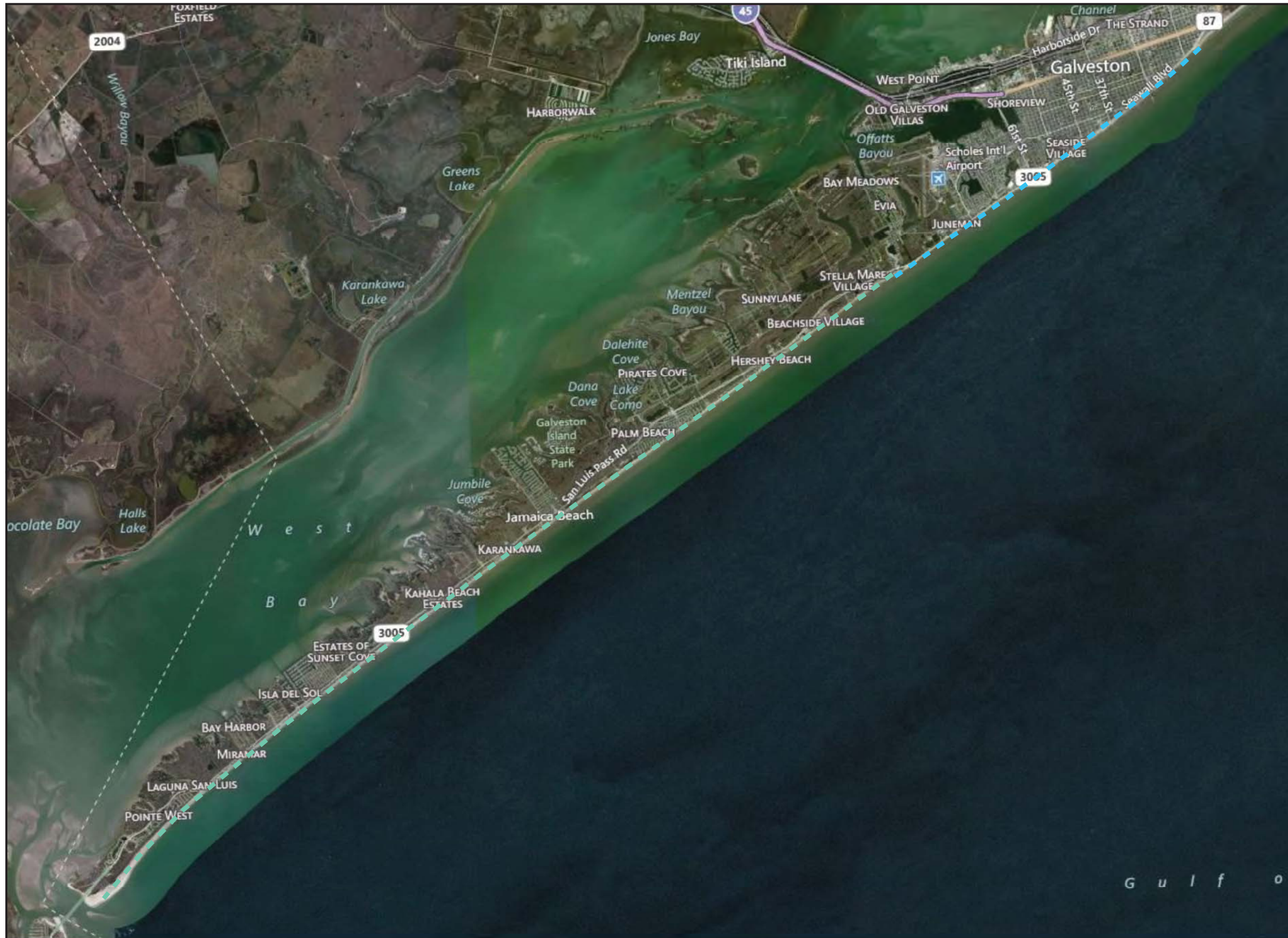

Legend

- - - Breakwaters - West End
- - - Breakwaters - East End



This product is reproduced from geospatial information prepared by the U.S. Army Corps of Engineers. GIS data and product accuracy may vary. Data may be developed from sources of differing accuracy, accurate only at certain scales, based on modeling or interpretation, incomplete while being created or revised, etc. Using GIS products for purposes other than those for which they were created may yield inaccurate or misleading results. The Corps of Engineers reserves the right to correct, update, modify, or replace GIS products without notifications.

Date Created: 2/26/2013



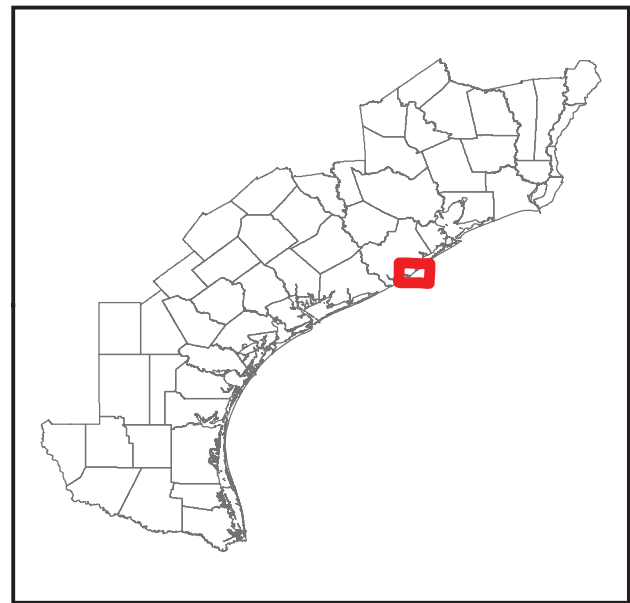
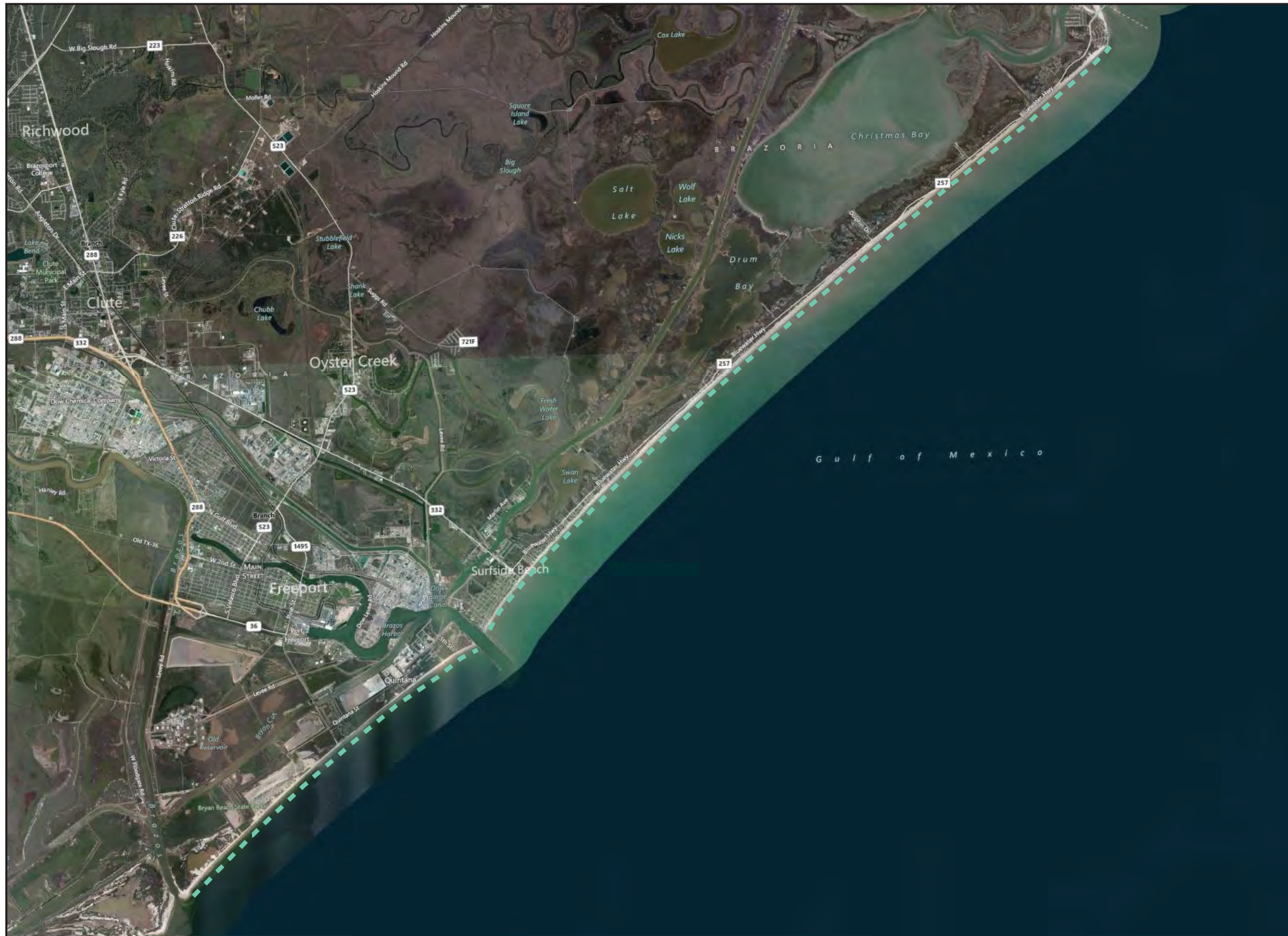

Measure 5-15: Segmented Nearshore Breakwaters, San Luis Pass to Brazos River Diversion Channel, Brazoria County



Legend

- - - Nearshore Breakwaters
- - - Nearshore Breakwaters



 0 2,800 5,600 11,200 16,800 22,400
 Feet

This product is reproduced from geospatial information prepared by the U.S. Army Corps of Engineers. GIS data and product accuracy may vary. Data may be developed from sources of differing accuracy, accurate only at certain scales, based on modeling or interpretation, incomplete while being created or revised, etc. Using GIS products for purposes other than those for which they were created may yield inaccurate or misleading results. The Corps of Engineers reserves the right to correct, update, modify, or replace GIS products without notifications.

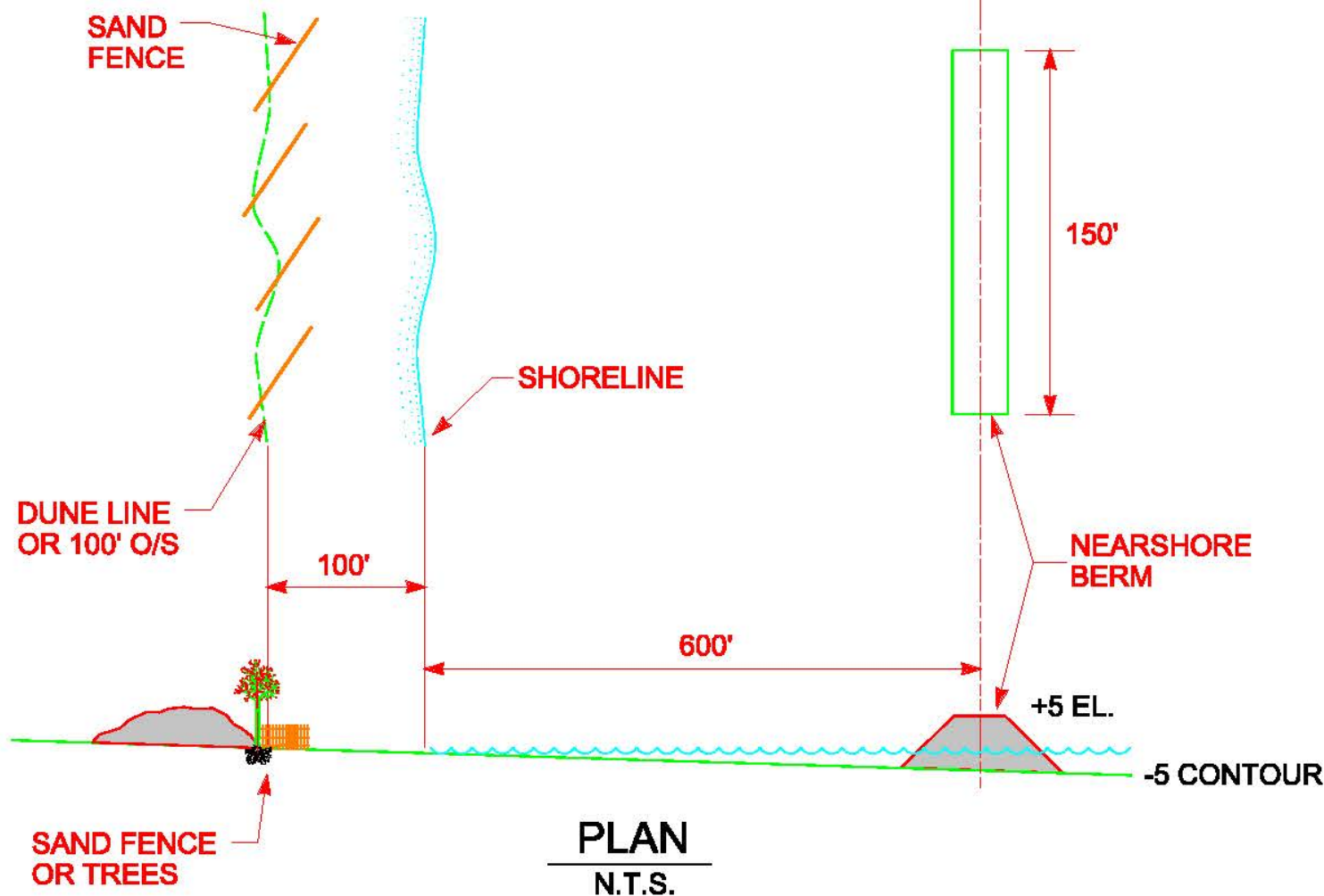
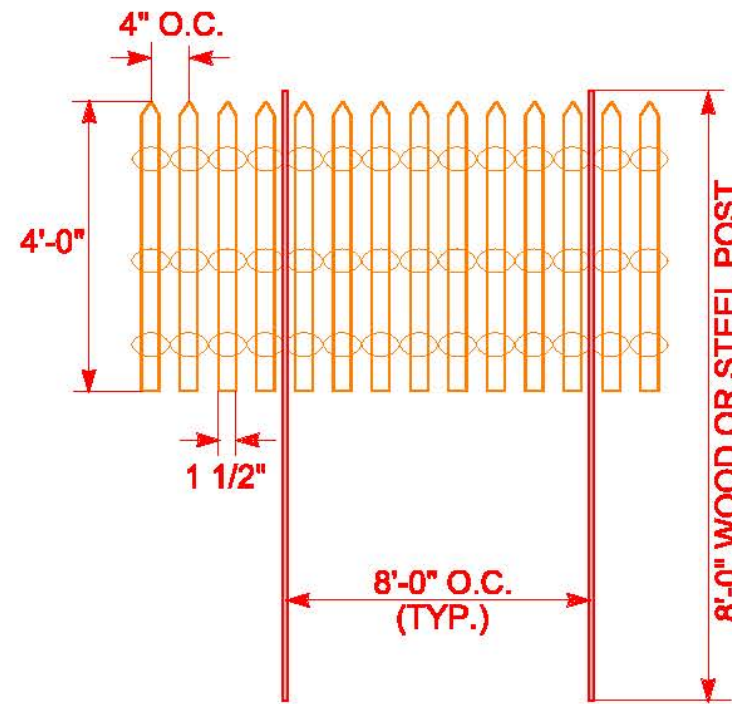
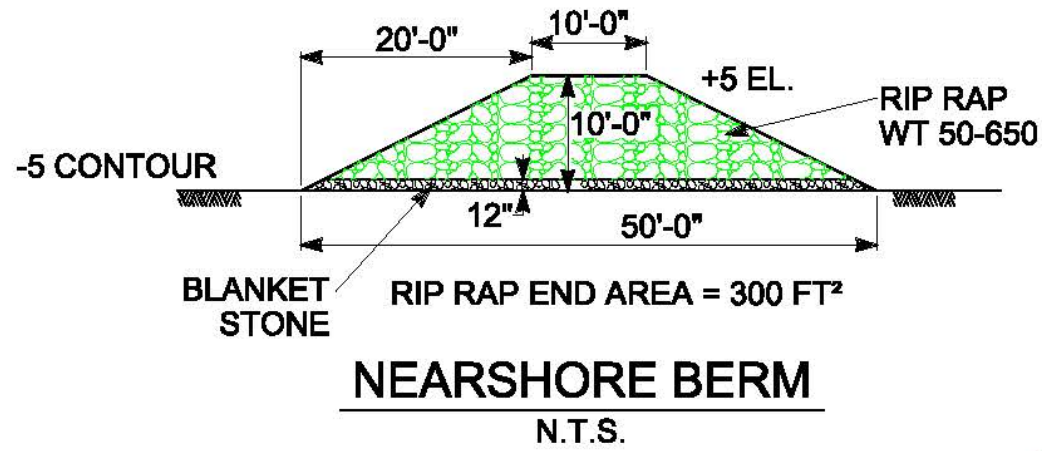
Typical Section S-11 Near Shore Segmented Breakwater

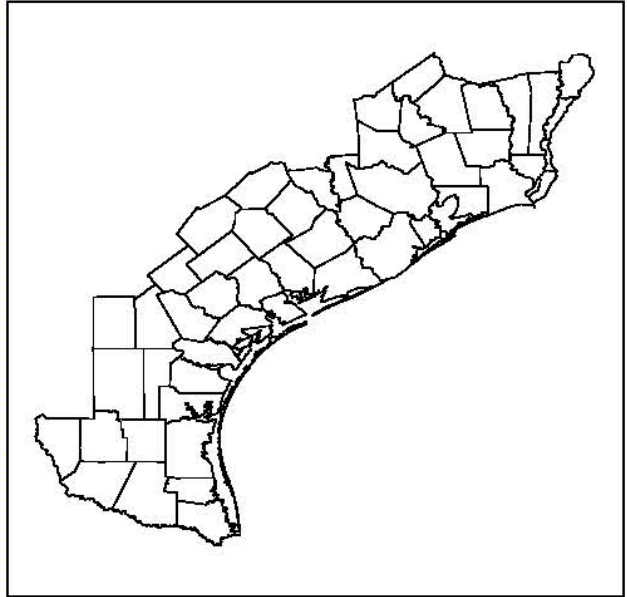

- ASSUMPTIONS:**
- 1: BREAKWATER IS PLACED AT -5' CONTOUR
 - 2: BREAKWATER IS 150 FT LONG
 - 3: BREAKWATERS ARE SPACED 300 FT APART
 - 4: VOLUME IS BASED ON CROSS SECTION AREA MULTIPLIED BY LENGTH
 - 5: TREE PLACED EVERY 15' OR SAND FENCE PLACED ALONG ESTABLISHED DUNE LINE OR 100' FROM EXISTING SHORELINE



Typical Section S-11

Measures:
5-5
5-9
5-15



This product is reproduced from geospatial information prepared by the U.S. Army Corps of Engineers. GIS data and product accuracy may vary. Data may be developed from sources of differing accuracy, accurate only at certain scales, based on modeling or interpretation, incomplete while being created or revised, etc. Using GIS products for purposes other than those for which they were created may yield inaccurate or misleading results. The Corps of Engineers reserves the right to correct, update, modify, or replace GIS products without notifications.

Date Created: 4/15/2013

