





Project Location is  
 N: 13672078.926026  
 E: 3304667.304231  
 Galveston Quadrangle  
 NAD 83 State Plane Texas South Central

 Project Location  
 Approximate Limits of Beach Nourishment

**ATKINS**

Sheet 1 of 14 Galveston Beach Nourishment  
 Vicinity Map  
 Permit SWG-2000-02888  
 Galveston Island Park Board of Trustees  
 Galveston, Galveston County, Texas

Datum: NAD 1983  
 Projection: State Plane Texas South Central  
 Units: Feet  
 Imagery: Nat Geo World

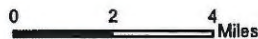

Job No.: 100054530	Scale: 1 in = 4 miles
Prepared By: ATKINS/WHIT6392	Date: Dec 06, 2017

N:\Client\IG\_Galveston\_Park\_Board\100054530\gsw\SWG\_2000\_02888\Permit\Map\Vicinity\_map\_02888\_v3.mxd



- Authorized Borrow Area<sup>1</sup>
- Proposed Borrow Area<sup>1</sup>
- Approximate Limits of Beach Nourishment
- Borrow Area Boundary
- Piping Plover Critical Habitat Unit

1. See Sheets 7-10 for Borrow Area Details

Datum: NAD 1983  
 Projection: State Plane  
 Texas South Central  
 Units: Feet  
 Imagery: ESRI World Imagery

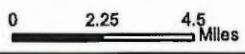

# ATKINS

Sheet 2 of 14  
**Galveston Beach Nourishment  
 Nourishment and Borrow Areas**  
 Permit SWG-2000-02888  
**Galveston Island Park Board of Trustees**  
 Galveston, Galveston County, Texas

Job No.: 100054530	Scale: 1 in = 4.5 miles
Prepared By: ATKINS/WHIT6392	Date: Dec 06, 2017

K:\GIS\2017\Galveston\_Park\_Board\100054530\gal\p\SWG-2000-02888\ATKINS\Map\SWG\_2000\_02888\_v1.mxd

Esri, DeLorme, USDA, USGS, AEX, GeoEye, GeoMapping, AeroGrid, IGN, IGP, and the GIS User Community. World Imagery. May 2015. 1:315,000. generated by ATKINS using ArcMap. <http://services.arcgis.com/ArcGISRest/services/World\_Imagery/MapServer> (06 December 2017)

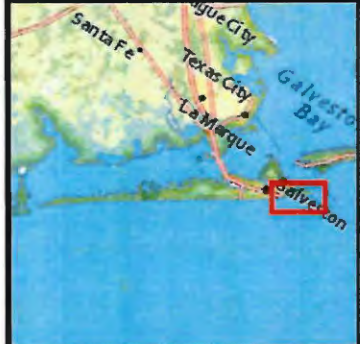
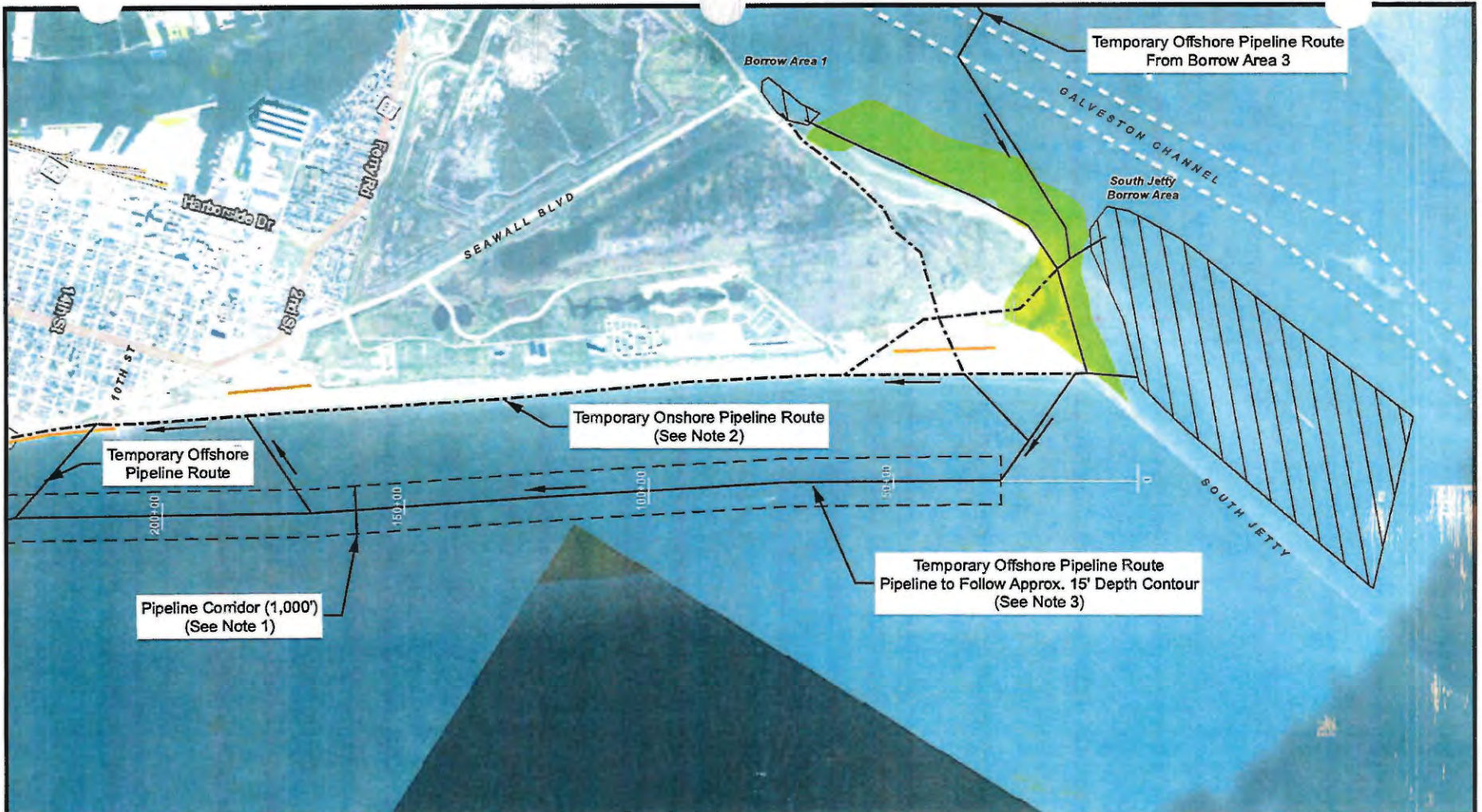

- Temporary Offshore Pipeline Route
- - - Temporary Onshore Pipeline Route
- - - Pipeline Corridor (1,000')
- Approximate Limits of Beach Nourishment
- ▭ Authorized Borrow Area
- ▭ Piping Plover Critical Habitat

Datum: NAD 1983  
 Projection: State Plane Texas South Central  
 Units: Feet  
 Imagery: ESRI World Imagery

NOTES:  
 1. OFFSHORE PIPELINE WILL BE SUBMERGED WITHIN PROPOSED CORRIDOR AND MARKED IN ACCORDANCE WITH U.S. COAST GUARD REQUIREMENTS  
 2. PIPELINE ON BEACH WILL BE PLACED LANDWARD OF THE MHW LINE.  
 3. APPLICANT MAY UTILIZE COMBINATION OF ONSHORE AND OFFSHORE METHODS FOR BRINGING DREDGE PIPE TO BEACH NOURISHMENT AREAS. PIPELINES POSITIONED NEARLY PERPENDICULAR TO THE BEACH WOULD BE UTILIZED TO CONVEY MATERIAL FROM THE OFFSHORE ROUTE AND/OR HOPPER DREDGE TO THE BEACH NOURISHMENT AREAS. LOCATIONS MAY VARY. HOPPER DREDGE DISTANCE FROM SHORE IS DEPENDENT ON BOTTOM CONTOURS, THIS MAY VARY.



Sheet 3 of 14  
 Galveston Beach Nourishment Pipeline Routes  
 Permit SWG-2000-02888  
 Galveston Island Park Board of Trustees  
 Galveston, Galveston County, Texas

Job No.: 100054530	Scale: 1" = 3,000'
Prepared By: Atkins/WHIT6392	Date: Dec 06, 2017

Esri, ArcGIS, USA, USGS, AEX, GeoEye, Getmapping, AeroGRID, IGN, IGP, and the GIS User Community, World Imagery, May 2015. 1:38,000; generated by Atkins; using ArcMap. < http://services.arcgis.com/ArcGIS/rest/services/World\_Imagery/MapServer (15 December 2017)

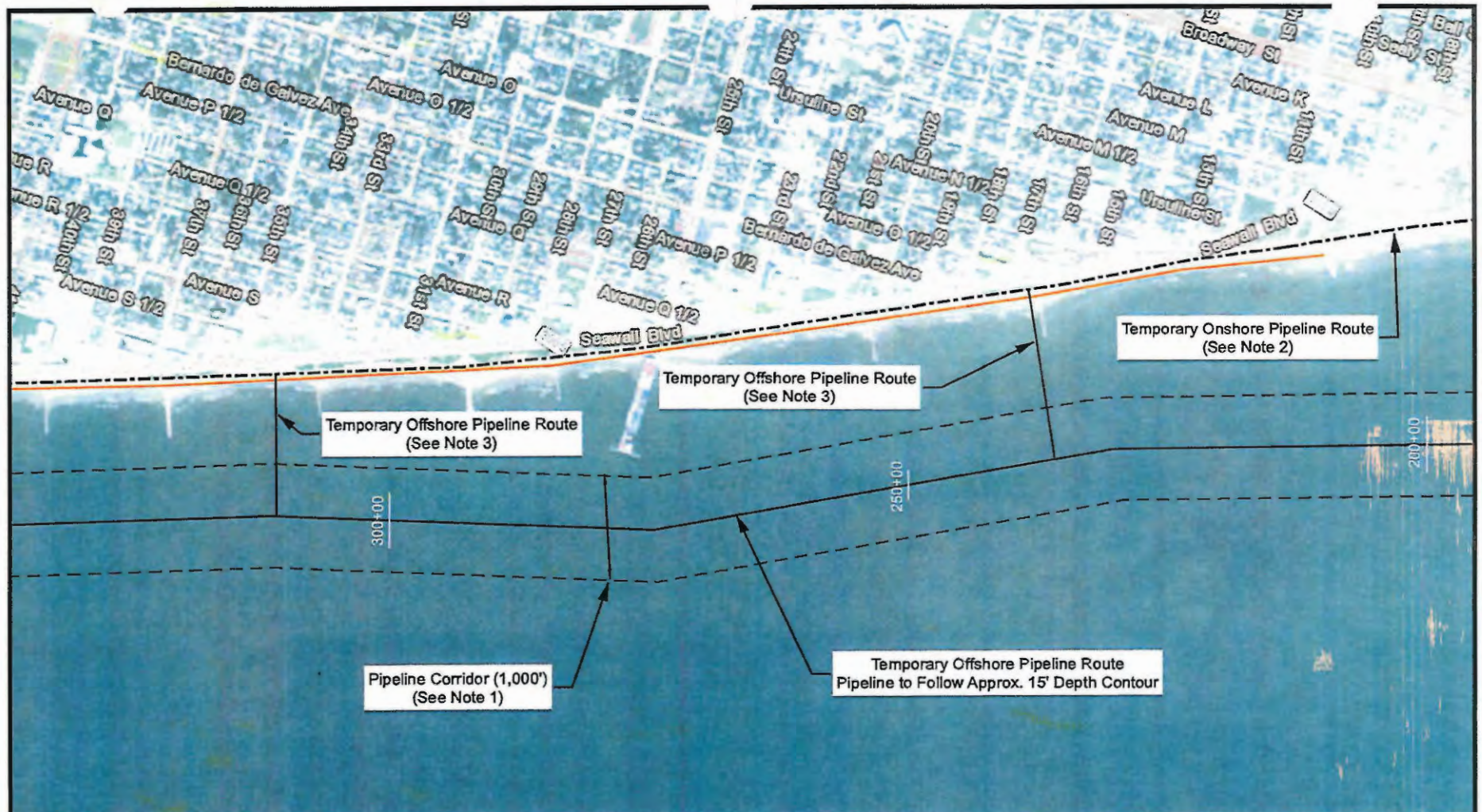

——— Temporary Offshore Pipeline Route  
 - - - - - Temporary Onshore Pipeline Route  
 - - - Pipeline Corridor (1,000')  
 ——— Approximate Proposed Limits of Beach Nourishment Area  
 - - - - - 5,000 ft Stationing

Datum: NAD 1983  
 Projection: State Plane Texas South Central  
 Units: Feet  
 Imagery: ESRI World Imagery

NOTES:

1. OFFSHORE PIPELINE WILL BE SUBMERGED WITHIN PROPOSED CORRIDOR AND MARKED IN ACCORDANCE WITH U.S. COAST GUARD REQUIREMENTS
2. PIPELINE ON BEACH WILL BE PLACED LANDWARD OF THE MHW LINE.
3. APPLICANT MAY UTILIZE COMBINATION OF ONSHORE AND OFFSHORE METHODS FOR BRINGING DREDGE PIPE TO BEACH NOURISHMENT AREAS. PIPELINES POSITIONED NEARLY PERPENDICULAR TO THE BEACH WOULD BE UTILIZED TO CONVEY MATERIAL FROM THE OFFSHORE ROUTE AND/OR HOPPER DREDGE TO THE BEACH NOURISHMENT AREAS. LOCATIONS MAY VARY. HOPPER DREDGE DISTANCE FROM SHORE IS DEPENDENT ON BOTTOM CONTOURS, THIS MAY VARY.

0 700 1,400 Feet

**ATKINS**

Sheet 4 of 14

Galveston Beach Nourishment Pipeline Routes

Permit SWG-2000-02888

Galveston Island Park Board of Trustees

Galveston, Galveston County, Texas

Job No.: 100054530	Scale: 1" = 1,400'
Prepared By: Atkins/WHIT6392	Date: Dec 06, 2017

\\C:\Users\j\Galveston\_Park\_Board\100054530\GIS\SWG\_2000\_02888\Permit\Final\Map\_Series\Background\_2.mxd

Esri, Intellicad, USDA, USGS, AEX, GeoEye, Geomapping, Aerogrid, IGN, IGP, and the GIS User Community. World Imagery, May 2015. 138,500; generated by Aitna; using ArcMap. < http://services.arcgis.com/ArcGIS/rest/services/World\_Imagery/MapServer > (08 December 2017)

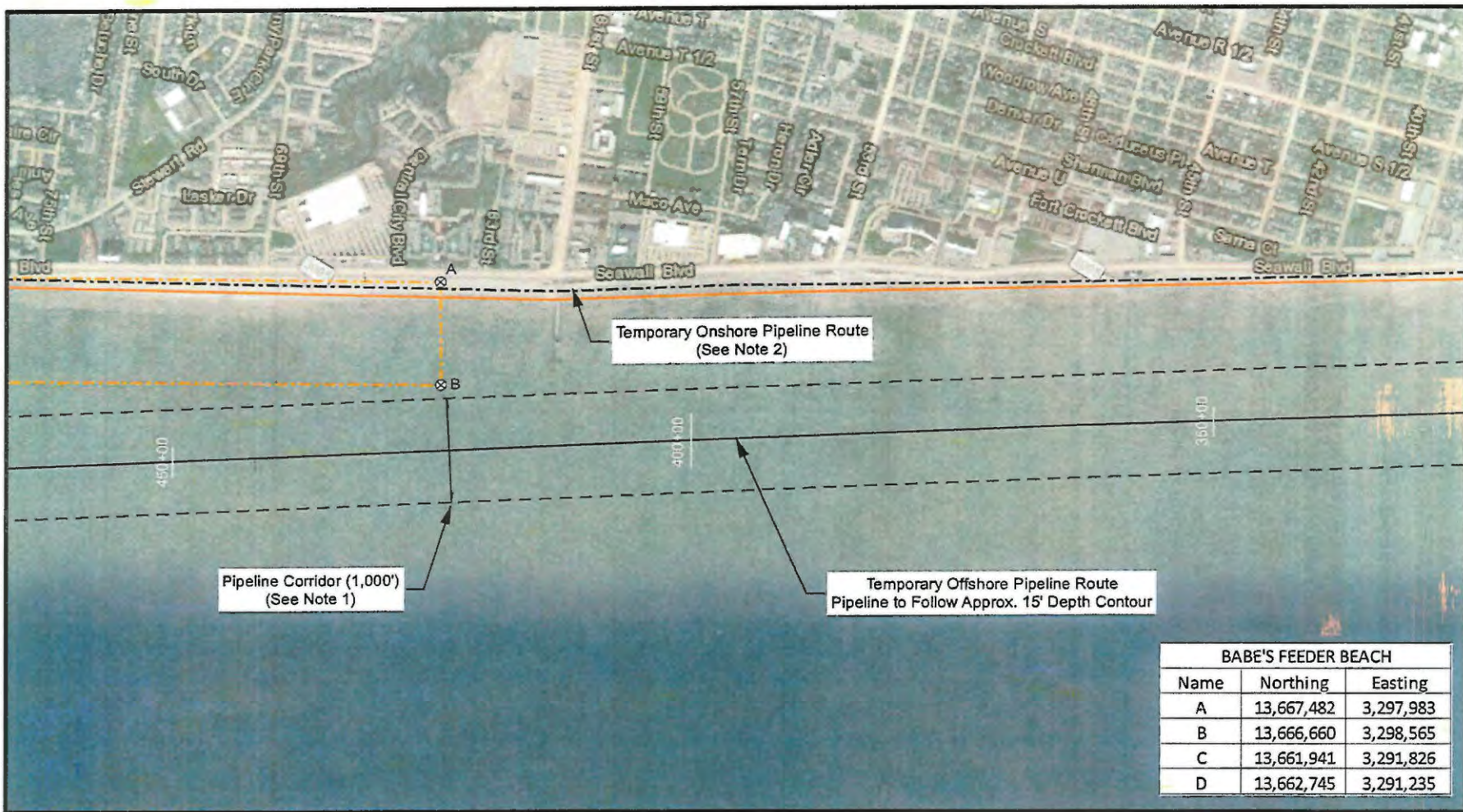

Pipeline Corridor (1,000')  
(See Note 1)

Temporary Onshore Pipeline Route  
(See Note 2)

Temporary Offshore Pipeline Route  
Pipeline to Follow Approx. 15' Depth Contour

BABE'S FEEDER BEACH		
Name	Northing	Easting
A	13,667,482	3,297,983
B	13,666,660	3,298,565
C	13,661,941	3,291,826
D	13,662,745	3,291,235



⊗ Coordinates      ▶ Typical Section Indicator

— Temporary Offshore Pipeline Route

- - - Temporary Onshore Pipeline Route

- - - Pipeline Corridor (1,000')

— Approximate Proposed Limits of Beach Nourishment Area

— Approximate Proposed Limits of Babe's Feeder Beach Nourishment Area

----- 5,000 ft Stationing

Datum: NAD 1983  
Projection: State Plane Texas South Central  
Units: Feet  
Imagery: ESRI World Imagery

NOTES:  
1. OFFSHORE PIPELINE WILL BE SUBMERGED WITHIN PROPOSED CORRIDOR AND MARKED IN ACCORDANCE WITH U.S. COAST GUARD REQUIREMENTS  
2. PIPELINE ON BEACH WILL BE PLACED LANDWARD OF THE MHW LINE  
3. APPLICANT MAY UTILIZE COMBINATION OF ONSHORE AND OFFSHORE METHODS FOR BRINGING DREDGE PIPE TO BEACH NOURISHMENT AREAS. PIPELINES POSITIONED NEARLY PERPENDICULAR TO THE BEACH WOULD BE UTILIZED TO CONVEY MATERIAL FROM THE OFFSHORE ROUTE AND/OR HOPPER DREDGE TO THE BEACH NOURISHMENT AREAS. LOCATIONS MAY VARY. HOPPER DREDGE DISTANCE FROM SHORE IS DEPENDENT ON BOTTOM CONTOURS, THIS MAY VARY.

0      700      1,400  
Feet

**ATKINS**

Sheet 5 of 14

Galveston Beach Nourishment Pipeline Routes

Permit SWG-2000-02888  
Galveston Island Park Board of Trustees

Galveston, Galveston County, Texas

Job No.: 100054530	Scale: 1" = 1,400'
Prepared By: Atkins/WHIT6392	Date: Dec 06, 2017

\\G:\GIS\Projects\Galveston\SWG-2000-02888\SWG-2000-02888\_PipelineRoutes\_Sheet5\_of\_14.aprx

Esri, ArcGIS, USA, USGS, AEX, GeoEye, GeoMapping, Aergrid, IGN, IOP, and the GIS User Community, World Imagery, May 2015, 1:38,000; generated by Atkins using ArcMap, < http://services.arcgisonline.com/ArcGIS/rest/services/World\_Imagery/MapServer > (20 March 2018)

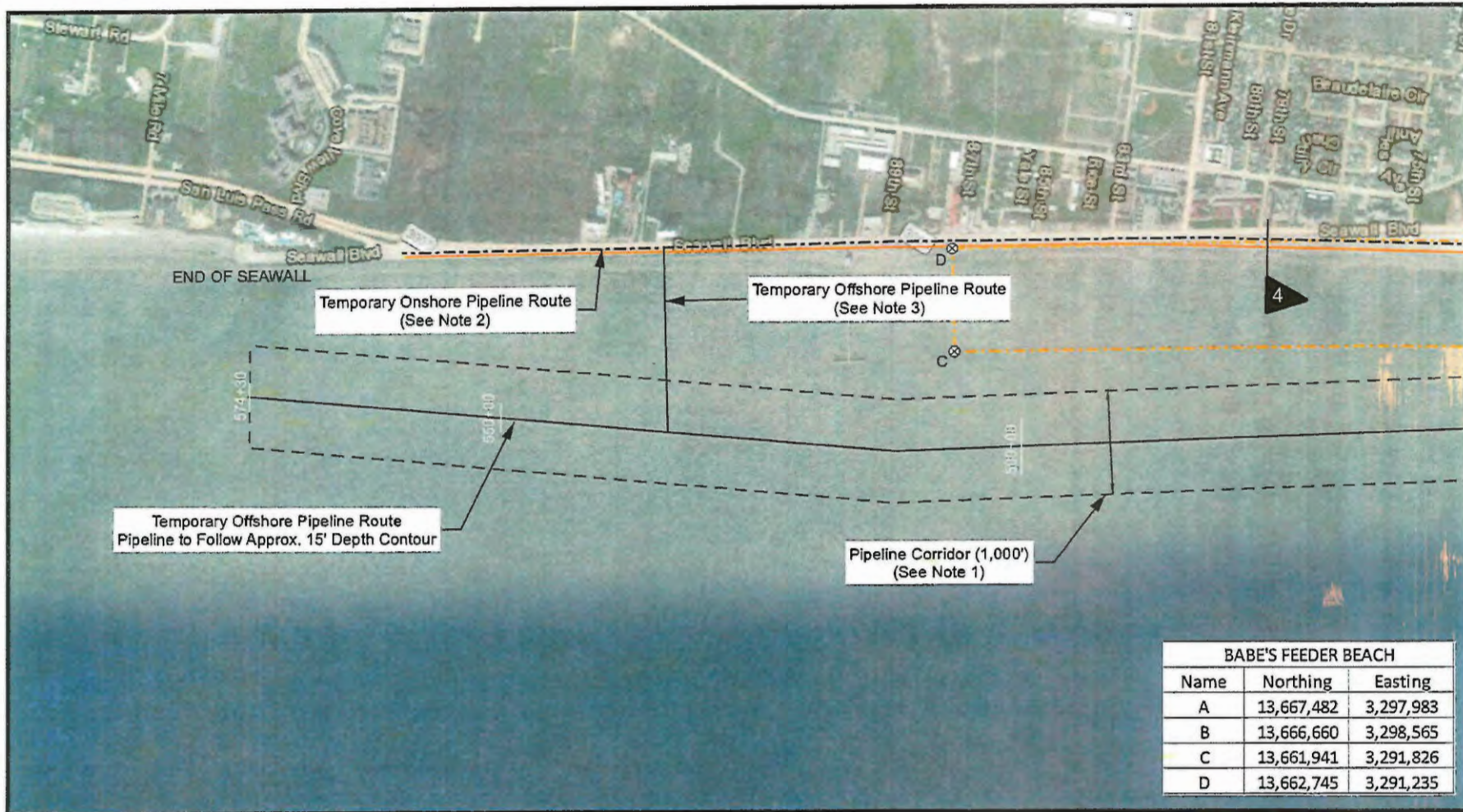

⊗ Coordinates      ▶ Typical Section Indicator

— Temporary Offshore Pipeline Route

- - - Temporary Onshore Pipeline Route

- - - Pipeline Corridor (1,000')

— Approximate Proposed Limits of Beach Nourishment Area

- - - Approximate Proposed Limits of Babe's Feeder Beach Nourishment Area

..... 5,000 ft Stationing

Datum: NAD 1983  
 Projection: State Plane Texas South Central  
 Units: Feet  
 Imagery: ESRI World Imagery

NOTES:

1. OFFSHORE PIPELINE WILL BE SUBMERGED WITHIN PROPOSED CORRIDOR AND MARKED IN ACCORDANCE WITH U.S. COAST GUARD REQUIREMENTS
2. PIPELINE ON BEACH WILL BE PLACED LANDWARD OF THE MHW LINE.
3. APPLICANT MAY UTILIZE COMBINATION OF ONSHORE AND OFFSHORE METHODS FOR BRINGING DREDGE PIPE TO BEACH NOURISHMENT AREAS. PIPELINES POSITIONED NEARLY PERPENDICULAR TO THE BEACH WOULD BE UTILIZED TO CONVEY MATERIAL FROM THE OFFSHORE ROUTE AND/OR HOPPER DREDGE TO THE BEACH NOURISHMENT AREAS. LOCATIONS MAY VARY. HOPPER DREDGE DISTANCE FROM SHORE IS DEPENDENT ON BOTTOM CONTOURS, THIS MAY VARY.

0      700      1,400  
 Feet

**ATKINS**

Sheet 6 of 14

Galveston Beach Nourishment Pipeline Routes

Permit SWG-2000-02888  
 Galveston Island Park Board of Trustees

Galveston, Galveston County, Texas

Job No.: 100054530	Scale: 1" = 1,400'
Prepared By: Atkins/WHIT6392	Date: Dec 06, 2017

Esri, InRoads, USDA, USGS, AIX, GeoEye, GeoMapping, AeroGRID, IGN, IOP, and the GIS User Community, World Imagery, May 2015, 138,800; generated by ATKINS using ArcMap. < http://services.arcgis.com/ArcGIS/rest/services/World\_Imagery/MapServer> (20 March 2018)

BORROW AREA 1		
Name	Northing	Easting
A	13,694,044	3,321,680
B	13,693,874	3,322,178
C	13,693,851	3,322,435
D	13,694,019	3,322,867
E	13,694,348	3,322,900
F	13,694,368	3,321,637
G	13,694,233	3,321,589

BORROW AREA 3		
Name	Northing	Easting
U	13,701,529	3,313,675
V	13,700,705	3,317,508
W	13,701,111	3,324,856
X	13,697,830	3,323,274
Y	13,696,945	3,316,066
Z	13,699,650	3,311,415

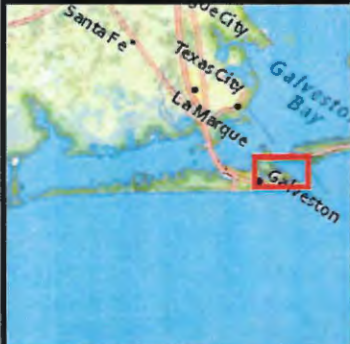
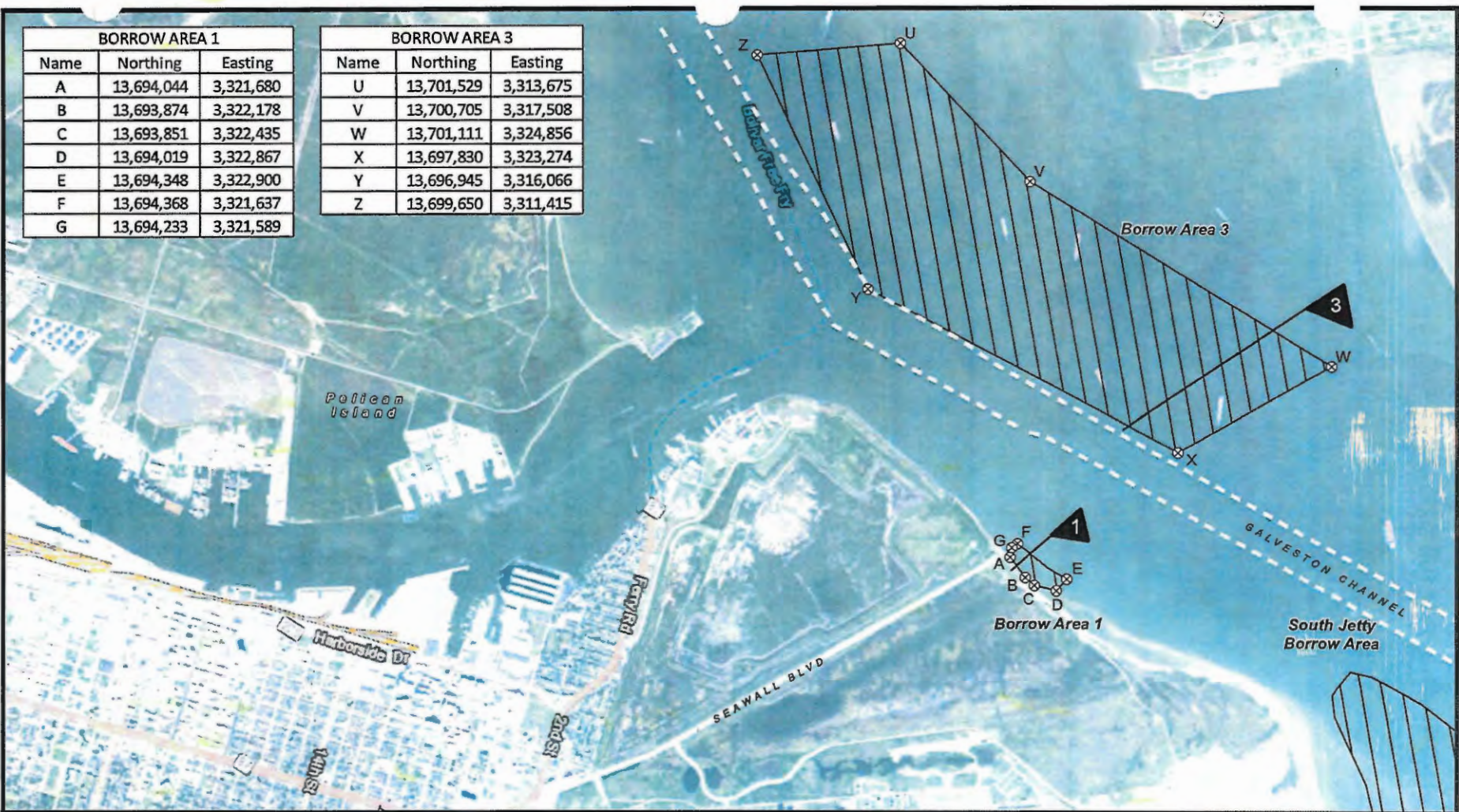

- ⊗ Coordinates
- ▨ Authorized Borrow Area
- Galveston Channel
- ▶ Typical Section Indicator

Datum: NAD 1983  
 Projection: State Plane Texas South Central  
 Units: Feet  
 Imagery: ESRI World Imagery



**ATKINS**

Sheet 7 of 14

Galveston Beach Nourishment  
 Borrow Areas 1 and 3  
 Permit SWG-2000-02888  
 Galveston Island Park Board of Trustees  
 Galveston, Galveston County, Texas

Job No.: 100054530	Scale: 1" = 3,000'
Prepared By: Atkins/WHIT6392	Date: Dec 06, 2017

Esri, Intellicast, USDA, USGS, AEX, GeoEye, GeoMapping, AeroGRID, IGN, IGP, and the GIS User Community. World Imagery, May 2015. 1:38,000; generated by ATKINS using ArcMap. <http://services.arcgisonline.com/ArcGIS/rest/services/World\_Imagery/MapServer> (06 December 2017)

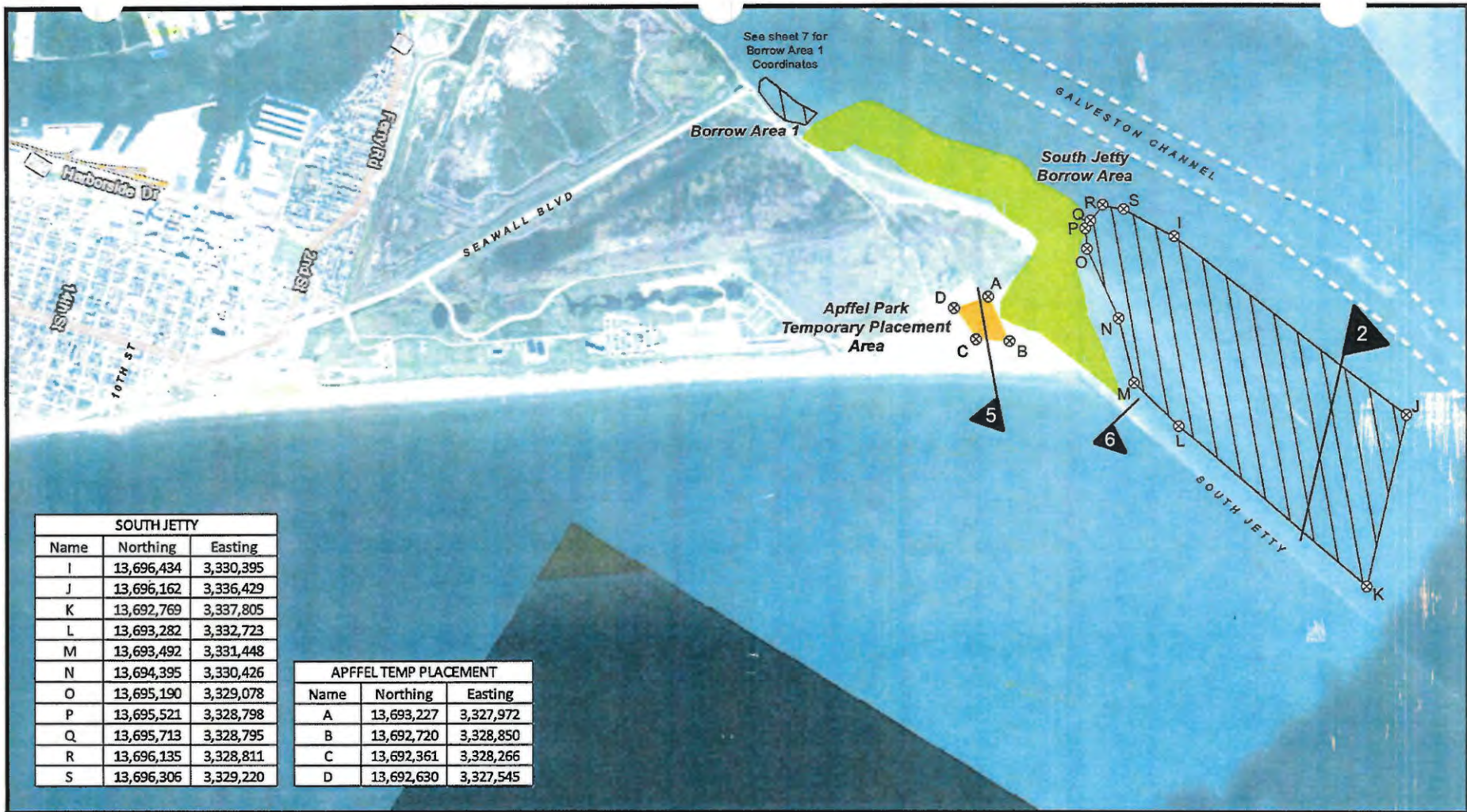

See sheet 7 for Borrow Area 1 Coordinates

SOUTH JETTY		
Name	Northing	Easting
I	13,696,434	3,330,395
J	13,696,162	3,336,429
K	13,692,769	3,337,805
L	13,693,282	3,332,723
M	13,693,492	3,331,448
N	13,694,395	3,330,426
O	13,695,190	3,329,078
P	13,695,521	3,328,798
Q	13,695,713	3,328,795
R	13,696,135	3,328,811
S	13,696,306	3,329,220

APFFEL TEMP PLACEMENT		
Name	Northing	Easting
A	13,693,227	3,327,972
B	13,692,720	3,328,850
C	13,692,361	3,328,266
D	13,692,630	3,327,545

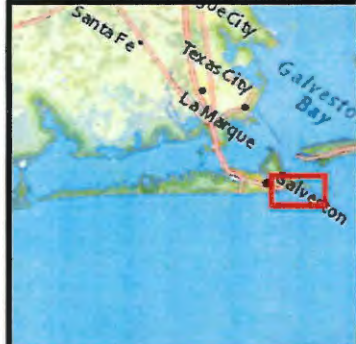

- ⊗ Coordinates
- ▭ Authorized Borrow Area
- ▭ Temporary Placement Area
- ▭ Piping Plover Critical Habitat
- ▭ Galveston Channel
- ▶ Typical Section Indicator

Datum: NAD 1983  
 Projection: State Plane Texas South Central  
 Units: Feet  
 Imagery: ESRI World Imagery



**ATKINS**

Sheet 8 of 14  
 Galveston Beach Nourishment  
 South Jetty Borrow Area and Apfel Park Temp Placement  
 Permit SWG-2000-02888  
 Galveston Island Park Board of Trustees  
 Galveston, Galveston County, Texas

Job No.: 100054530	Scale: 1" = 3,000'
Prepared By: Atkins/WHIT6392	Date: Dec 06, 2017

Esri, i-cubed, USDA, USGS, AEX, GeoEye, Getmapping, Aerogrid, IGN, IGP, and the GIS User Community. World Imagery. May 2015. 1:28,000; generated by Atkins; using ArcMap. <http://services.arcgisonline.com/ArcGIS/rest/services/World\_Imagery/MapServer> (06 December 2017)



**R R RYAN INVESTMENTS INC**  
(SWG-1992-02768)

Name	Northing	Easting
A	13,678,158	3,287,415
B	13,678,445	3,287,976
C	13,677,510	3,288,455
D	13,677,223	3,287,894

**WEST GULF MARINE WORKS LTD**

Name	Northing	Easting
E	13,680,000	3,292,560
F	13,680,261	3,293,427
G	13,679,217	3,293,962
H	13,679,079	3,293,052

**TEXAS INTERNATIONAL TERMINALS LTD**  
(5600 PIB Corp)

Name	Northing	Easting
O	13,683,471	3,294,807
P	13,684,200	3,296,966
Q	13,681,328	3,297,934
R	13,680,284	3,297,948
S	13,679,889	3,297,118
T	13,679,533	3,296,133

**GCAD PROPERTY ID 293637**

Name	Northing	Easting
U	13,684,200	3,296,966
V	13,684,392	3,297,535
W	13,684,091	3,299,010
X	13,681,202	3,298,008

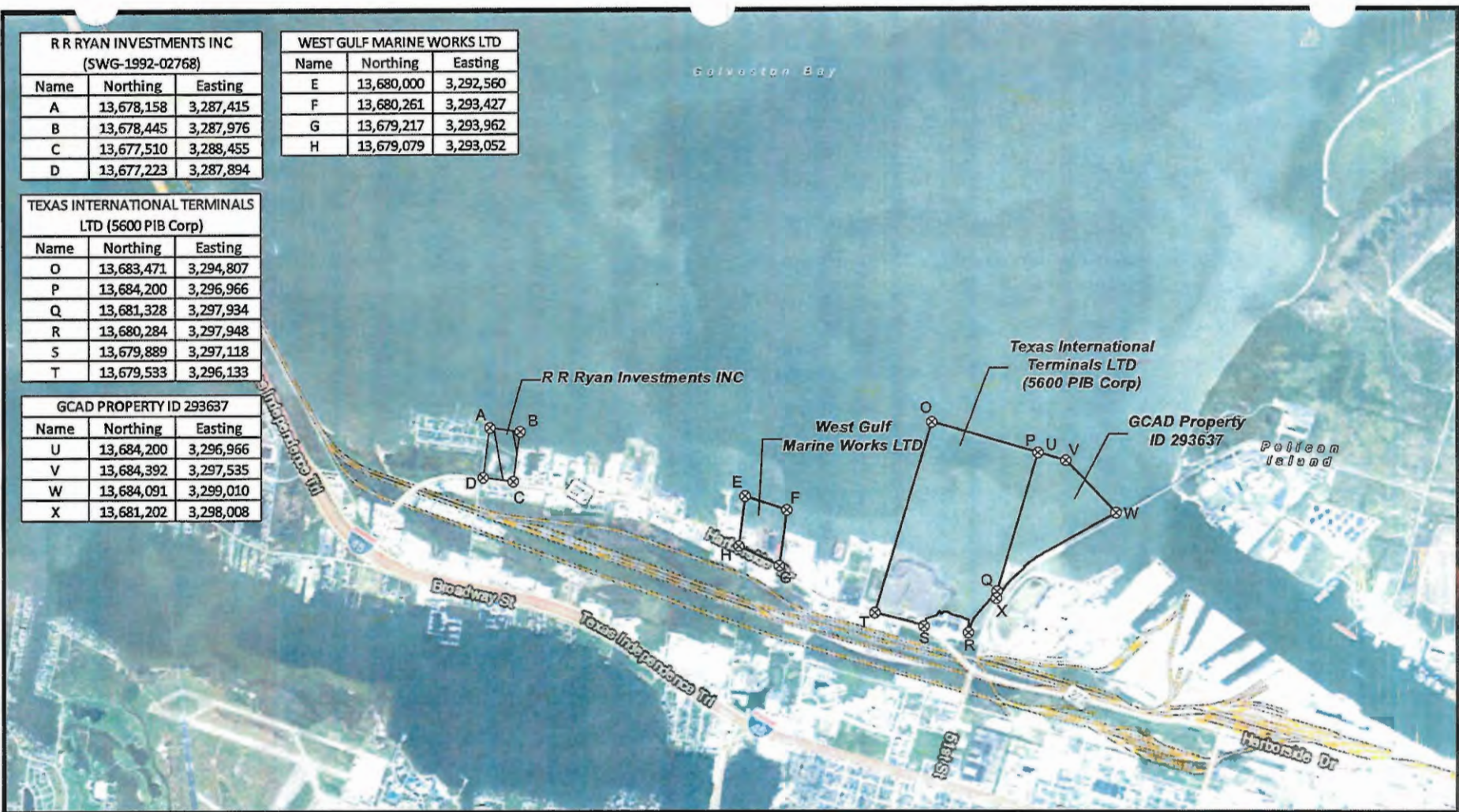

**ATKINS**

Sheet 9 of 14

Galveston Beach Nourishment  
Submerged Borrow Areas

Permit SWG-2000-02888  
Galveston Island Park Board of Trustees  
Galveston, Galveston County, Texas

Job No.: 100054530	Scale: 1" = 3,000'
Prepared By: Atkins/WHIT6392	Date: Dec 06, 2017

Datum: NAD 1983  
Projection: State Plane Texas South Central  
Units: Feet  
Imagery: ESRI World Imagery

0 1,500 3,000 Feet

**ATKINS**

Sheet 9 of 14

Galveston Beach Nourishment  
Submerged Borrow Areas

Permit SWG-2000-02888  
Galveston Island Park Board of Trustees  
Galveston, Galveston County, Texas

Job No.: 100054530	Scale: 1" = 3,000'
Prepared By: Atkins/WHIT6392	Date: Dec 06, 2017

H:\Clients\G\_H\Galveston\_Park\_Board\110054530\GIS\SWG\_2000\_02888\Permit\Borrow\_Areas\Submerged\_BorrowAreas.mxd

Eri, I-cubed, USDA, USGS, AES, GeoEye, Getmapping, AeroGRID, IGN, IGP, and the GIS User Community, World Imagery, May 2015, 1:38,000; generated by Atkins using ArcMap, <http://services.arcgisonline.com/ArcGIS/rest/services/World\_Imagery/MapServer> (15 December 2017)

SUNBIRD/SUNSET COVE SUBDIVISION		
Name	Northing	Easting
Q	13,621,657	3,232,530
R	13,622,355	3,233,446
S	13,622,114	3,233,634
T	13,621,397	3,232,723

STAVANGER		
Name	Northing	Easting
K	13,610,925	3,220,297
L	13,611,797	3,219,617
M	13,611,875	3,219,724
N	13,611,356	3,220,111
O	13,611,654	3,220,495
P	13,611,302	3,220,752

SULLIVAN LAND & CATTLE CO		
Name	Northing	Easting
A	13,662,845	3,274,588
B	13,663,320	3,275,497
C	13,664,340	3,275,021
D	13,665,048	3,276,516
E	13,663,904	3,277,095
F	13,662,572	3,276,494
G	13,661,989	3,275,013

PEPPER COVE IN TERRAMAR BEACH SUBDIVISION		
Name	Northing	Easting
A	13,617,235	3,225,587
B	13,617,794	3,226,487
C	13,617,301	3,226,996
D	13,617,262	3,226,867
E	13,617,230	3,226,513
F	13,617,082	3,226,392
G	13,617,161	3,225,640

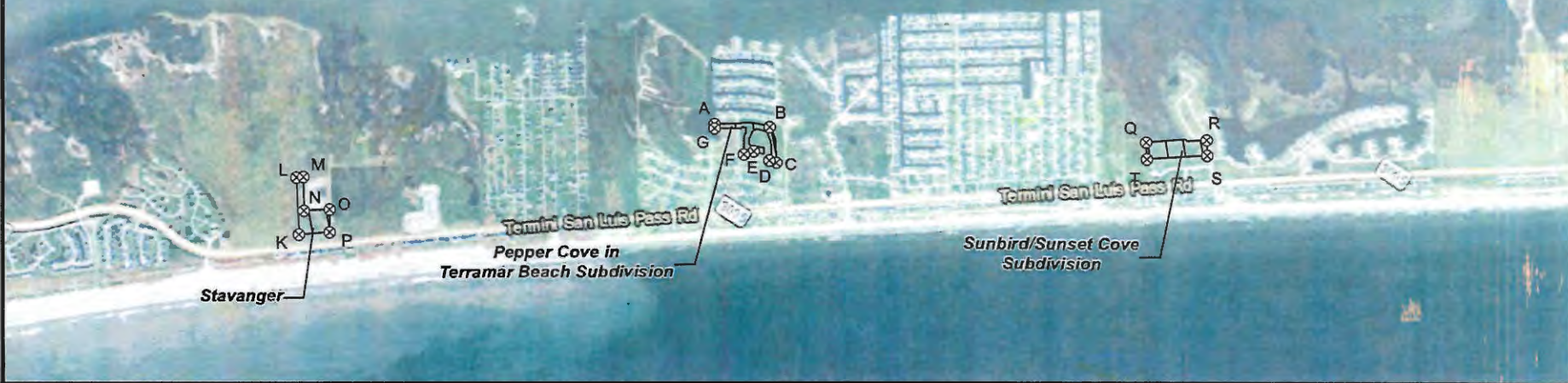

- ⊗ Coordinates
- ▭ Proposed Borrow Area
- ▨ Authorized Borrow Area

Datum: NAD 1983  
 Projection: State Plane Texas South Central  
 Units: Feet  
 Imagery: ESRI World Imagery

Sunbird/Sunset Cove Subdivision, Stavanger, Pepper Cove in Terramar Beach Subdivision, and Sullivan Land and Cattle Co Borrow Areas



Sheet 10 of 14  
 Galveston Beach Nourishment  
 Proposed and Authorized Borrow Areas  
 Permit SWG-2000-02888  
 Galveston Island Park Board of Trustees  
 Galveston, Galveston County, Texas

Job No.: 100054530	Scale: 1" = 3,000'
Prepared By: Atkins/WHIT6392	Date: Dec 06, 2017



Esri, I-cubed, USDA, USGS, AEX, GeoEye, GeoMapping, AeroGRID, IGN, IGP, and the GIS User Community. World Imagery. May 2015. 1:25,000; generated by ATKINS; using ArcMap. <http://services.arcgisonline.com/ArcGIS/rest/services/World\_Imagery/MapServer> (15 December 2017)

H:\Projects\Galveston\_Park\_Board\10054\DWG\10054\_SWG\_2000\_02888\10054\_SWG\_2000\_02888.dwg

**UPLAND DREDGED MATERIAL PLACEMENT AREA (DMPA) PLAN  
RYAN MARINE (SWG-1992-02768)**

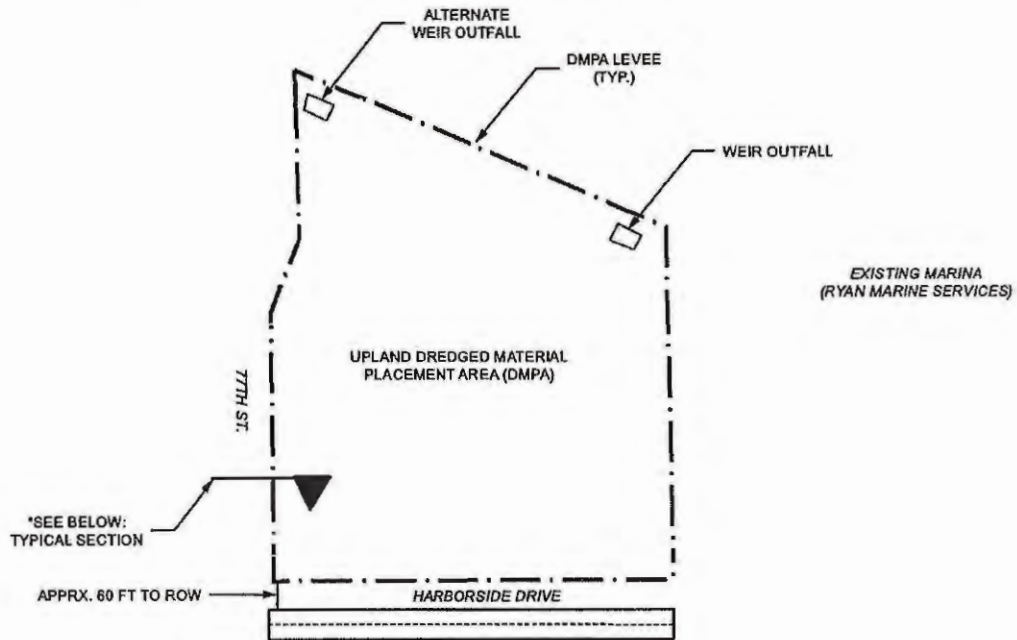

**TYPICAL SECTION - DMPA LEVEE\***

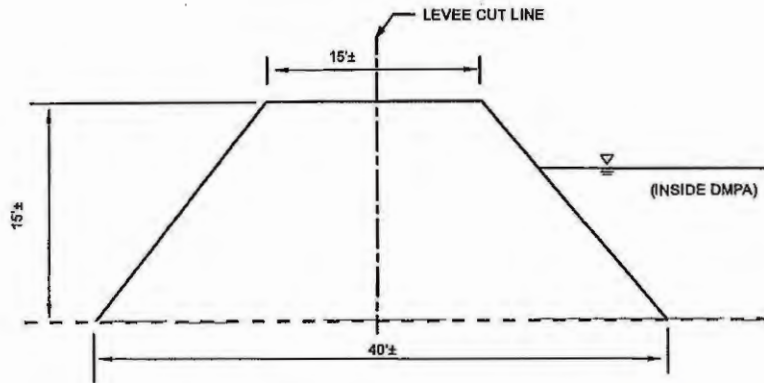

**NOTES:**

1. ALL ELEVATIONS ARE IN FEET AND REFER TO NAVD' 88



Sheet 11 of 14

Galveston Beach Nourishment  
Placement Area Typical Section

Permit SWG-2000-02888  
Galveston Island Park Board of Trustees

Galveston, Galveston County, Texas

Job No.: 100054530

Scale: Not to scale

Prepared By: ATKINS/WHIT6392

Date: Dec 06, 2017

R:\Clients\10\_Galveston\_Park\_Board\100054530\p02\5p1\SWG\_2000\_02888\Drawings\11\_Harbor\Drawings.dwg

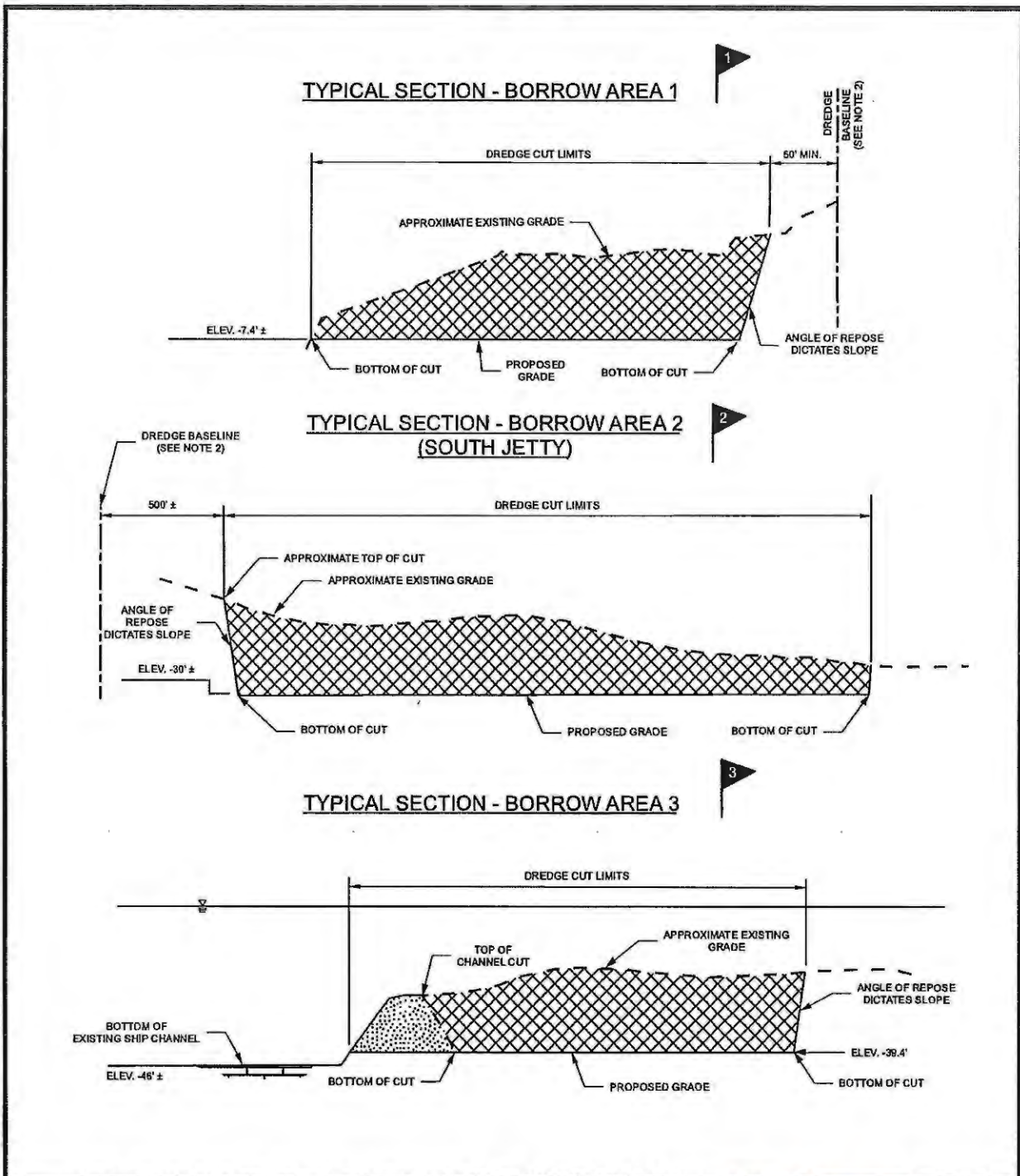

- NOTES:**
1. ALL ELEVATIONS ARE IN FEET AND REFER TO NAVD' 88
  2. DREDGE BASELINE IS APPROXIMATE CENTERLINE OF EXISTING SOUTH JETTY

**ATKINS**

Sheet 12 of 14  
 Galveston Beach Nourishment  
 Borrow Area Typical Sections

Permit SWG-2000-02888  
**Galveston Island Park Board of Trustees**

Galveston, Galveston County, Texas

Job No.: 100054530	Scale: Not to scale
Prepared By: ATKINS/WHIT6392	Date: Dec 06, 2017

N:\Chen\10\_Galveston\_Park\_Board\100054530\p12\12\_000\_02888\Permit\Drawings\03\_Borrow\_1\_2and\_3.dwg

**TYPICAL BEACH NOURISHMENT SECTION**

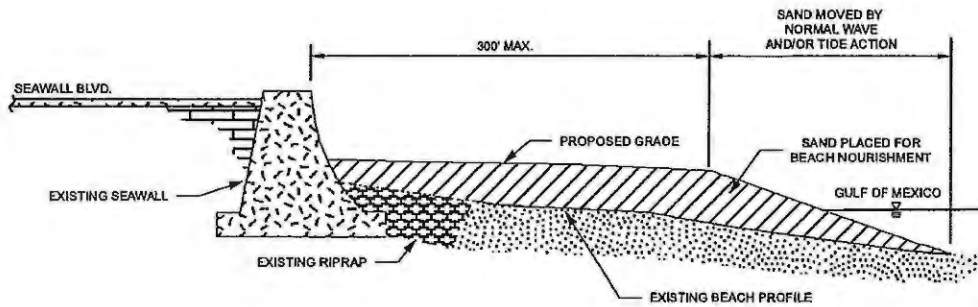

**TYPICAL SECTION - DMPA CONTAINMENT LEVEE**

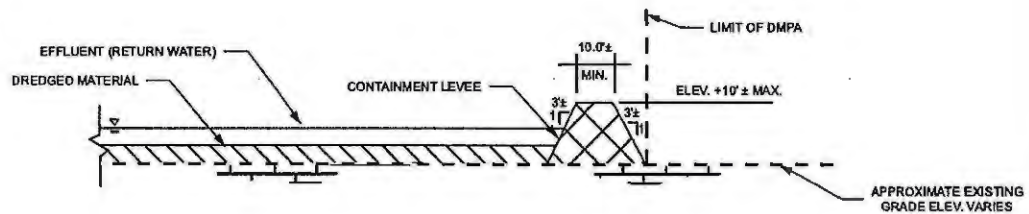

**NOTES:**

1. ALL ELEVATIONS ARE IN FEET AND REFER TO NAVD' 88

**ATKINS**

Sheet 13 of 14

Galveston Beach Nourishment  
Typical Sections

Permit SWG-2000-02888  
Galveston Island Park Board of Trustees

Galveston, Galveston County, Texas

Job No.: 100054530

Scale: Not to scale

Prepared By: ATKINS/WHIT6392

Date: Dec 06, 2017

H:\Clients\G\_H\Galveston\_Park\_Board\100054530\p01\fig\SWG\_2000\_02888\Permit\Cross\_sections\03\_Beach\_nourishment\_DMPA\_v2.mxd

**TYPICAL SECTION - SOUTH JETTY/GROIN DREDGE PIPELINE CROSSING**

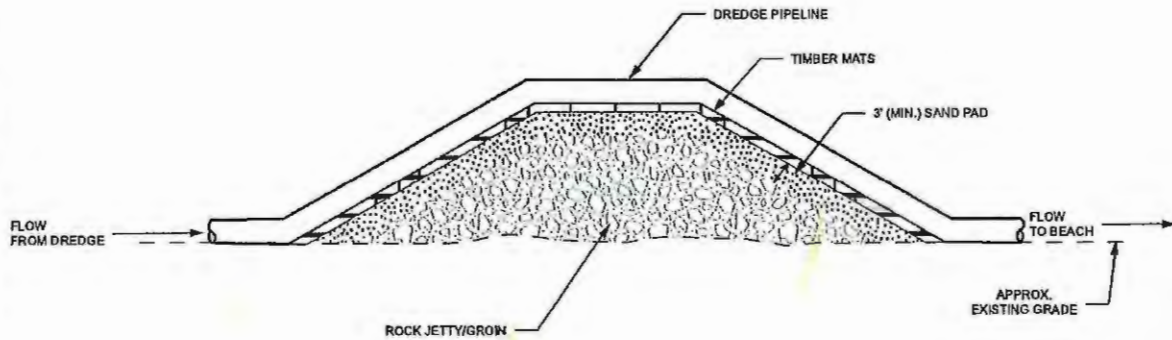

**NOTES:**

1. AT SOUTH JETTY AND 10<sup>TH</sup> ST. GROIN, DREDGE PIPELINE SHALL BE ROUTED SO THAT JETTY/GROIN CROSSING OCCURS AT A LOCATION WHERE MINIMAL SAND PLACEMENT IS REQUIRED TO ACCOMPLISH 3' COVER. WHERE ADDITIONAL SAND IS NEEDED, IT MAY BE REDISTRIBUTED FROM NON-VEGETATED AREAS IMMEDIATELY ADJACENT TO CROSSING. SAND SHALL BE RETURNED TO ITS ORIGINAL LOCATION AT COMPLETION OF PROJECT.
2. WEST OF 10<sup>TH</sup> STREET, SOURCE OF MATERIAL FOR SAND PAD SHALL BE DREDGED MATERIAL FROM DESIGNATED BORROW AREAS. SAND SHALL BE GRADED WITHIN BEACH NOURISHMENT TEMPLATE AT PROJECT COMPLETION.

**ATKINS**

Sheet 14 of 14

Galveston Beach Nourishment  
Jetty/Groin Crossing Typical Section  
Permit SWG-2000-02888  
Galveston Island Park Board of Trustees  
Galveston, Galveston County, Texas

Job No.: 100054530

Scale: Not to scale

Prepared By: ATKINS/WHIT6392

Date: Dec 06, 2017

N:\Clients\10\_Hydro\Galveston\_Park\_Board\100054530\gpo\101010\_2009\_02888\Final\Cross\_sections\14\_JettyCrossing.psd